



FAMU-FSU  
College of  
Engineering

# Virtual Design Review 4

## Team 510 – Danfoss IGV

01/30/2024





# Team Overview



Joseph Bechara  
*Controls Engineer*



Hunter Dabbs  
*Systems Engineer*



Tye Fountain  
*Mechanical Design  
Engineer*



Thiago Todesco  
*Manufacturing  
Engineer*



# Sponsor and Advisor



Engineering Mentor  
Bruce Barnett  
*Manufacturing Engineer  
(Retired)*



Engineering Mentor  
Yiwei Liu  
*Manufacturing Engineer*



Academic Advisor  
Shayne McConomy, Ph.D.  
*Teaching Faculty II*

# Background



# Project Overview

What functions the fixture needs to accomplish

What the current method performs poorly or not being measured

What parameters are currently being measured

Detect blade open/close, ball indicator movement and Inlet Guide Vane model

Motor movement

What functions the fixture needs to accomplish



# Objective

Develop an apparatus that tests the functionality of four different Danfoss Inlet Guide Vanes (IGVs), giving relevant data and prompting the operator with a pass or fail message.

# Danfoss

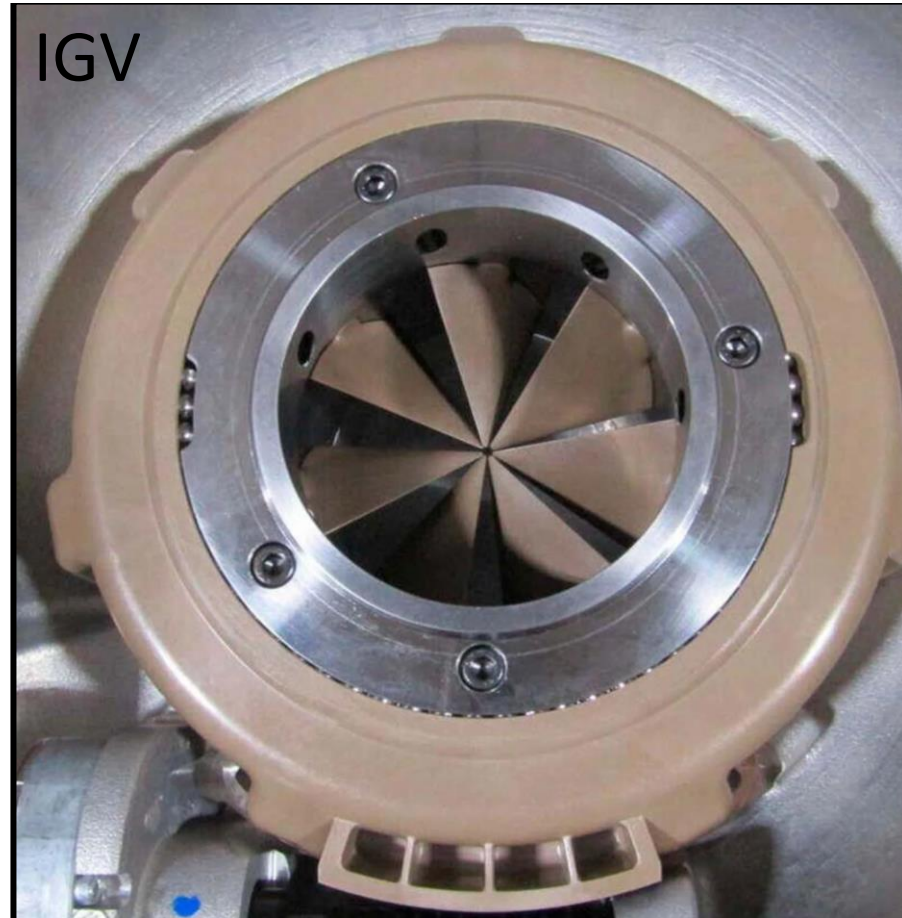

# Assumptions



Responsibility for  
all Documentation



Test fixture fits  
into existing  
workstation

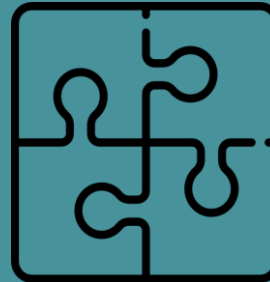

Production ready  
IGV



Operators able to  
lift 50 pounds

# Key Goals

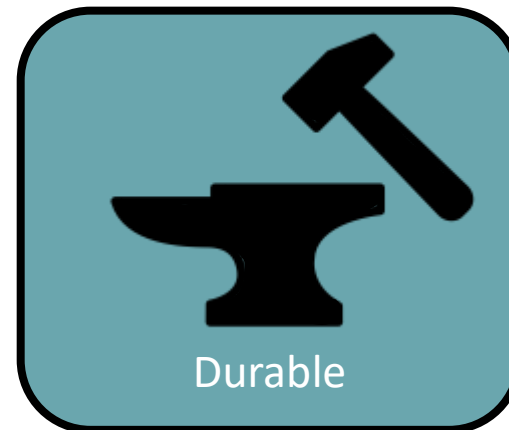
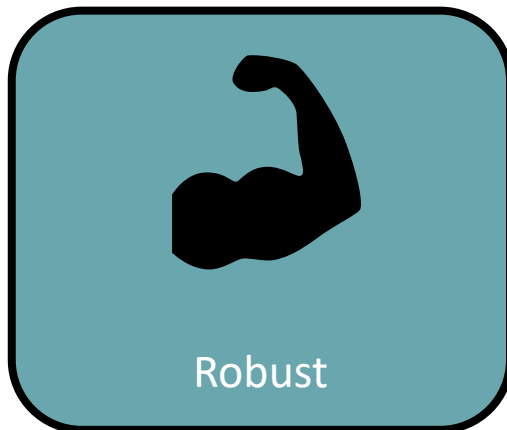
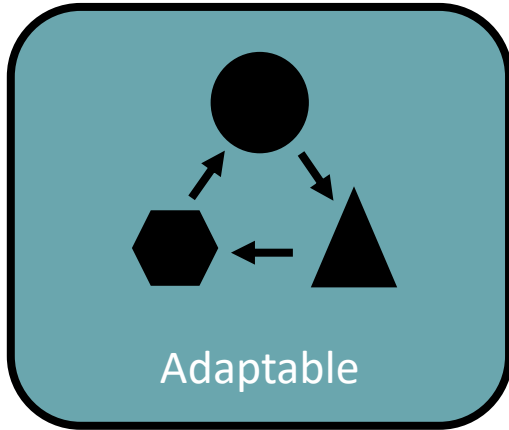



# Targets and Metrics

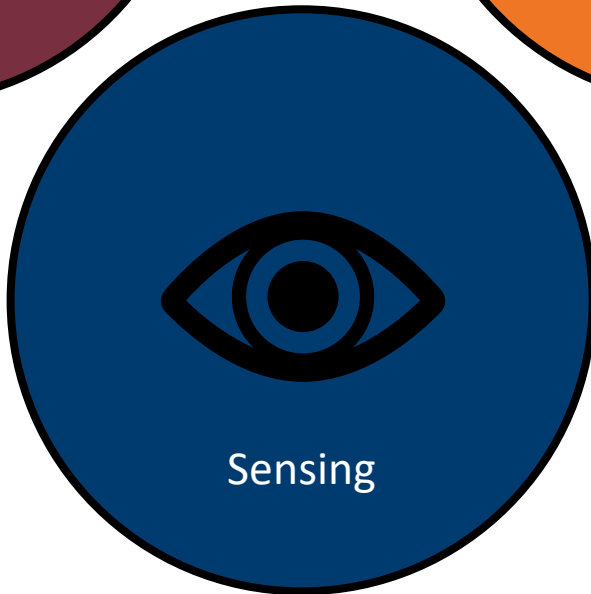
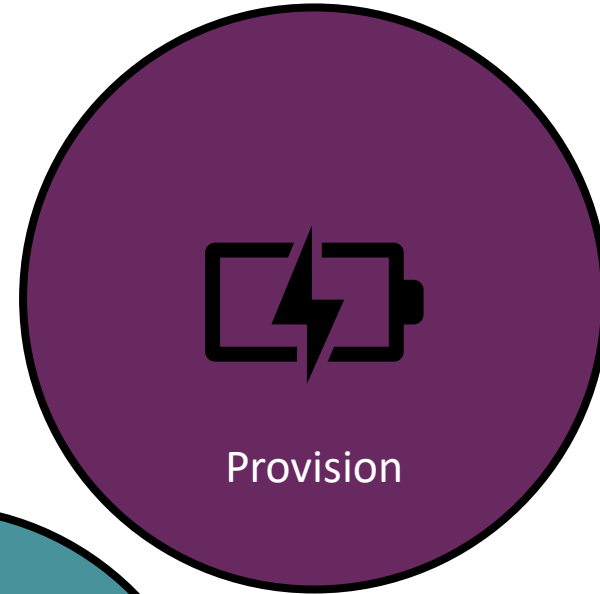
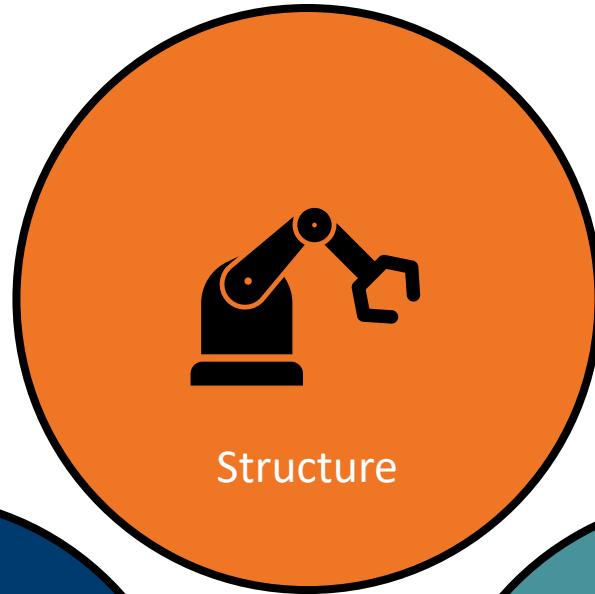
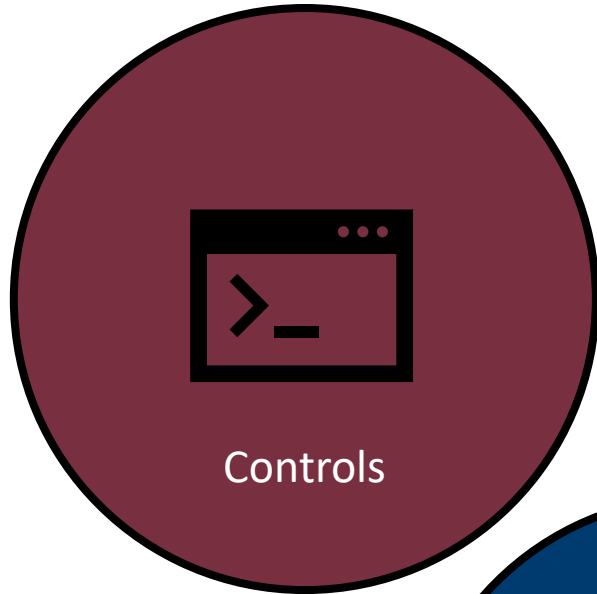

# Targets and Metrics

Determining IGV model

Tracking movement of IGV blades

Tracking test state

Tracking ball indicator location

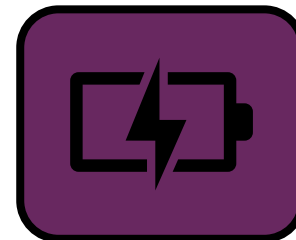
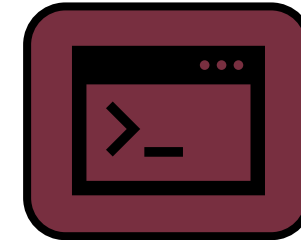
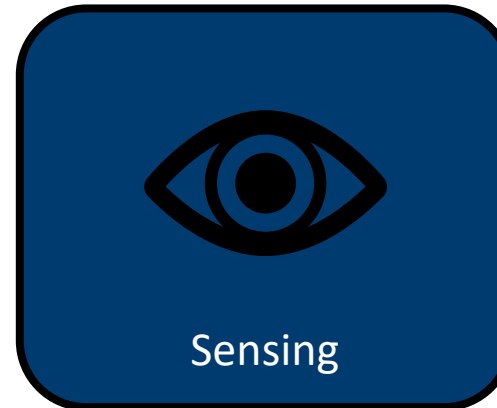
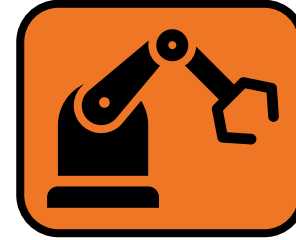

# Targets and Metrics

Start/Stop test

Open/Close IGV

Read and process  
ball indicator  
location

Store test data

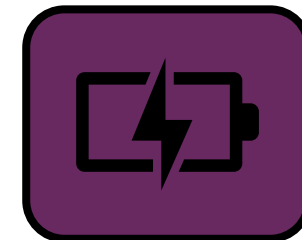
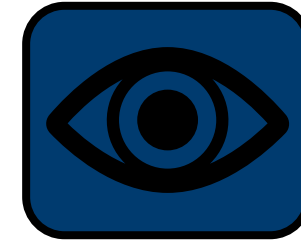
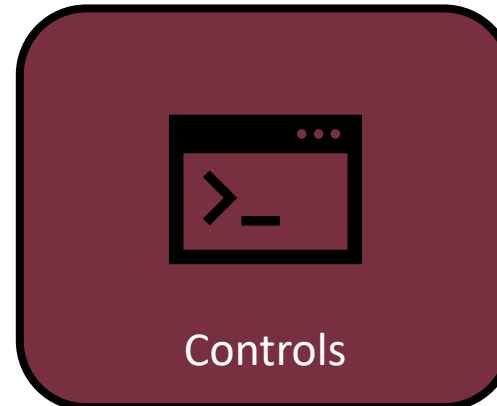
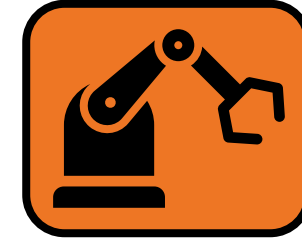



# Targets and Metrics

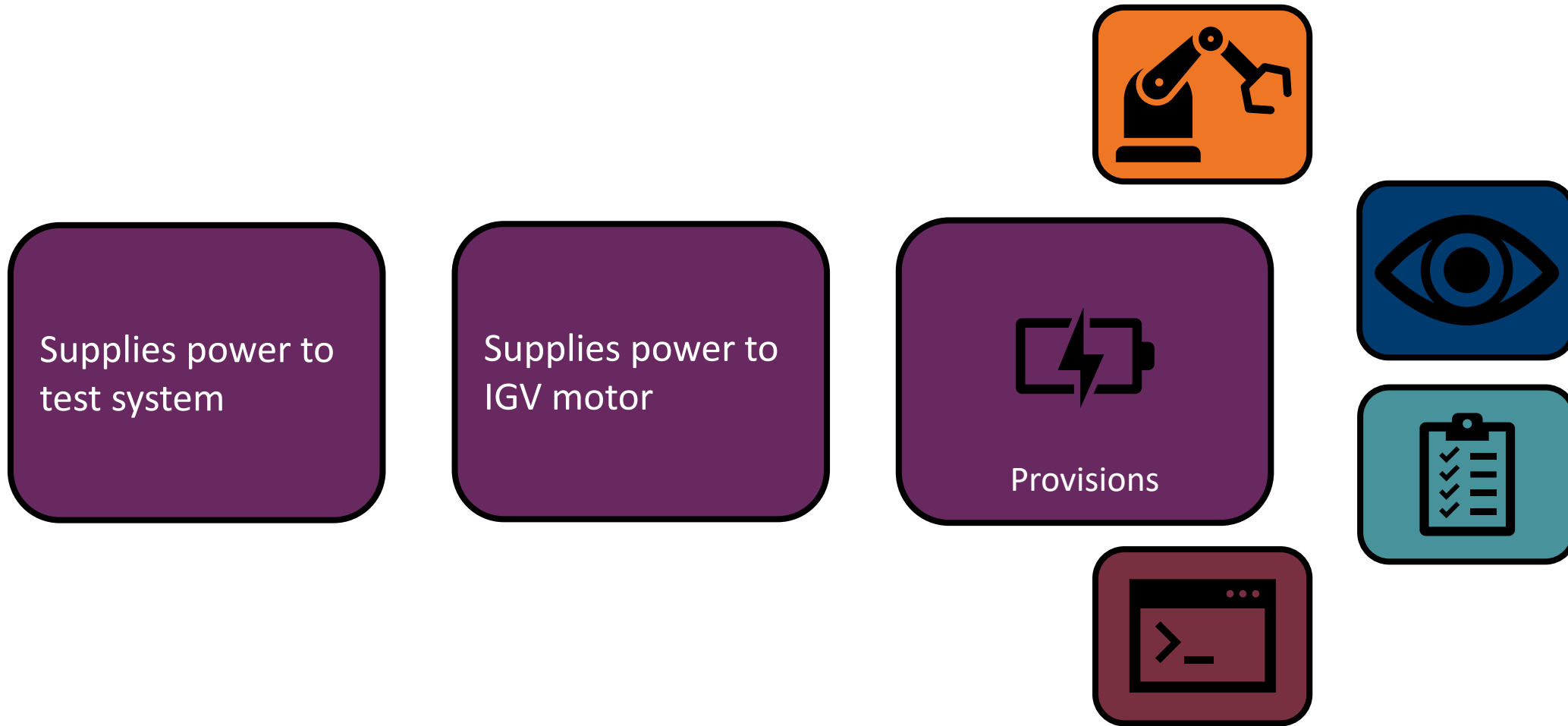

# Targets and Metrics

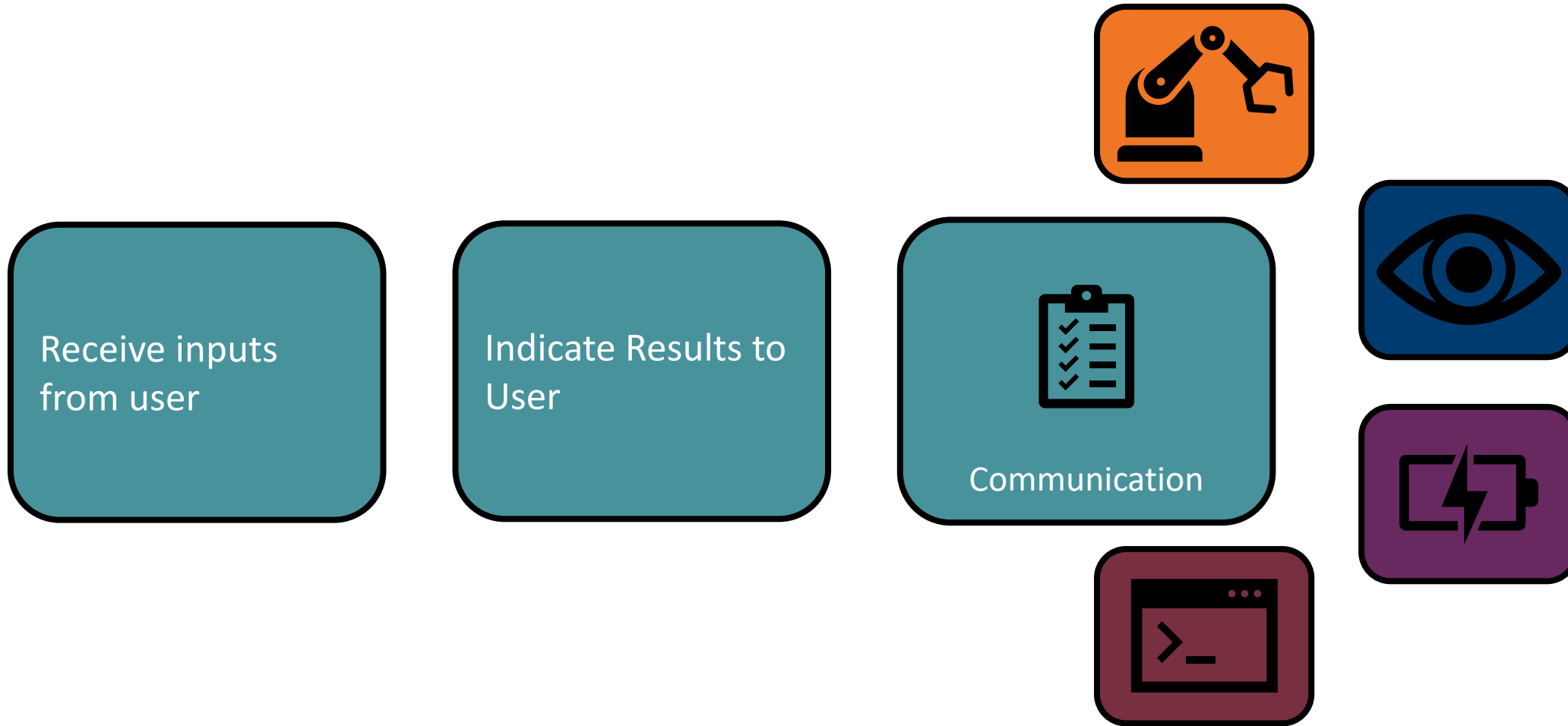

# Targets and Metrics

Resist an impact force of 10 Newtons

Prevent tipping with a max force of 10 Newtons at the top

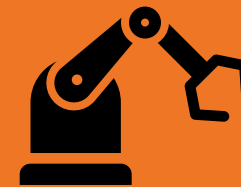

Structure

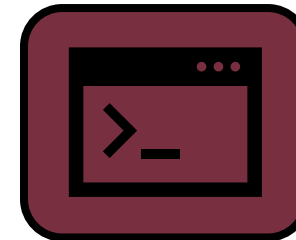
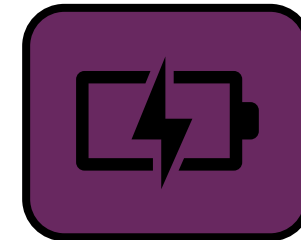
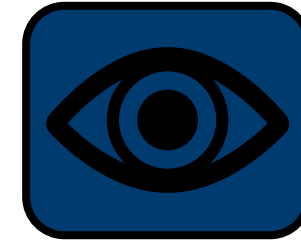



# Final Selection

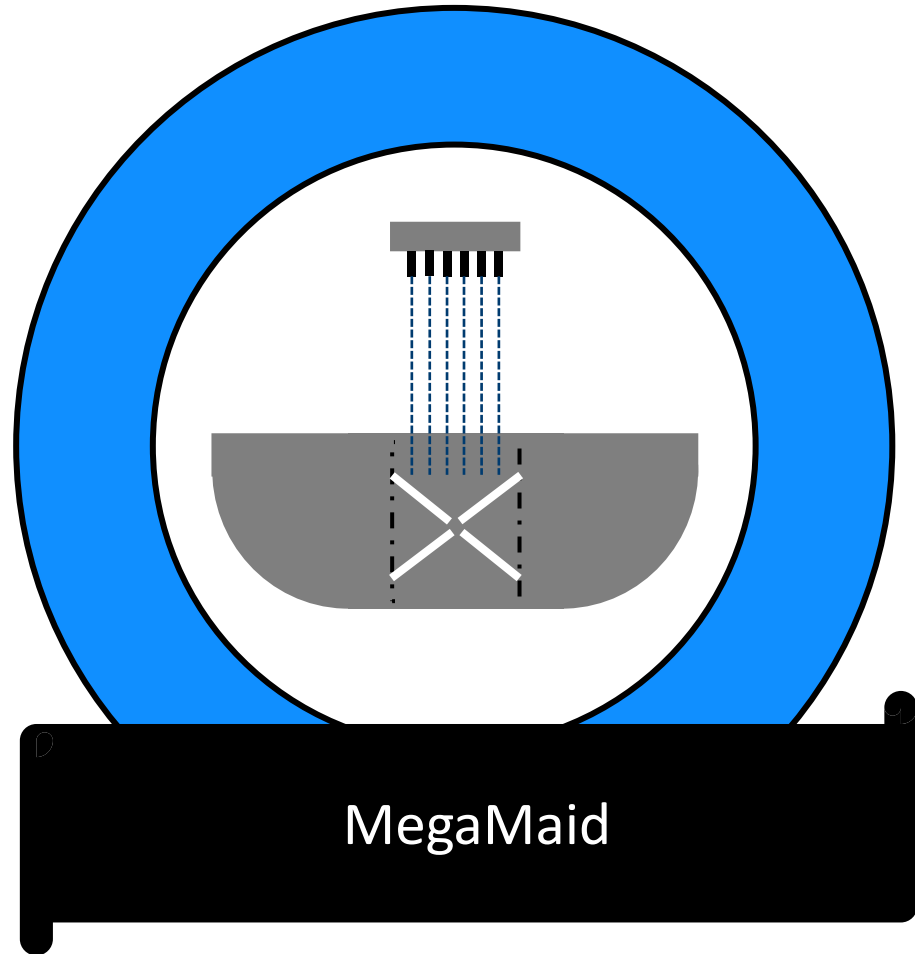

Stable design



Accurate and precise

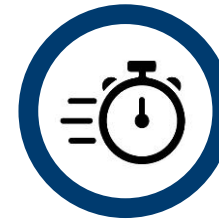

Fast



Durable

# Current Design

- Utilize Existing Baseplate
- L-Shaped Beam
- Two-Axis Movement
- Laser Transmitter and Receiver Modules

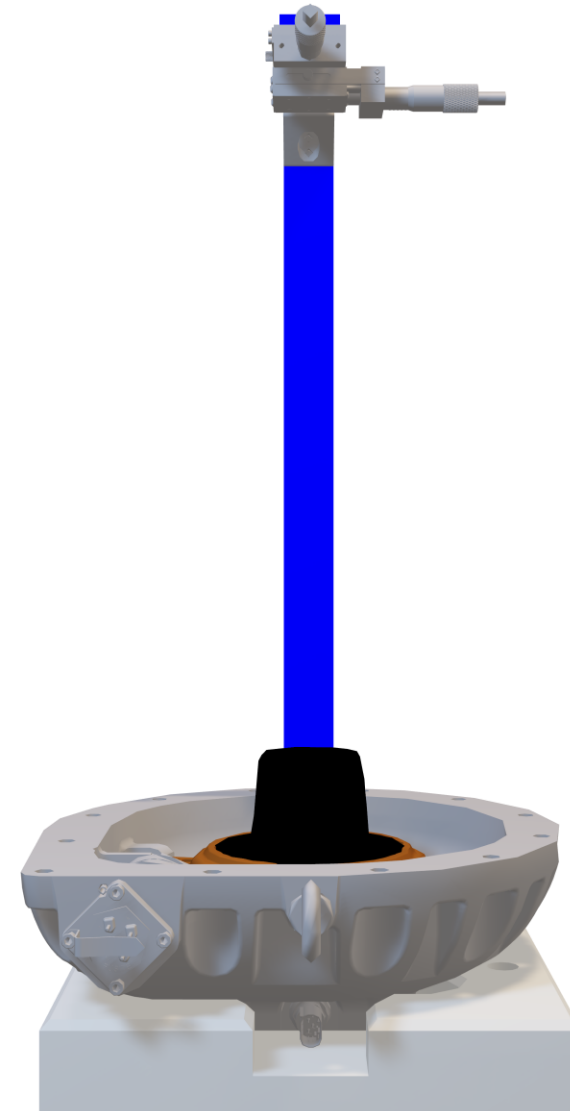

# Current Design Structural Frame



Aluminum Frame



3 Rectangular Aluminum Bars



Gussets

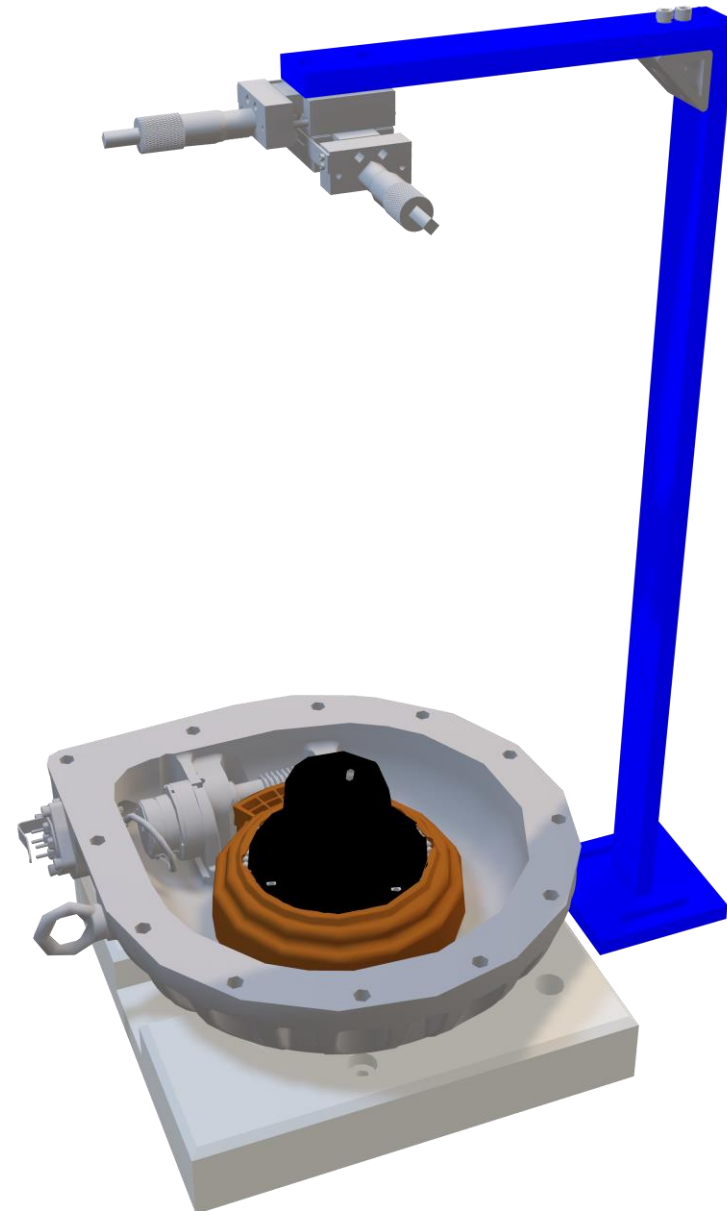



# Current Design Mobility



Base Movement



Two Axis Movement



Linear x-axis Movement



Linear y-axis Movement

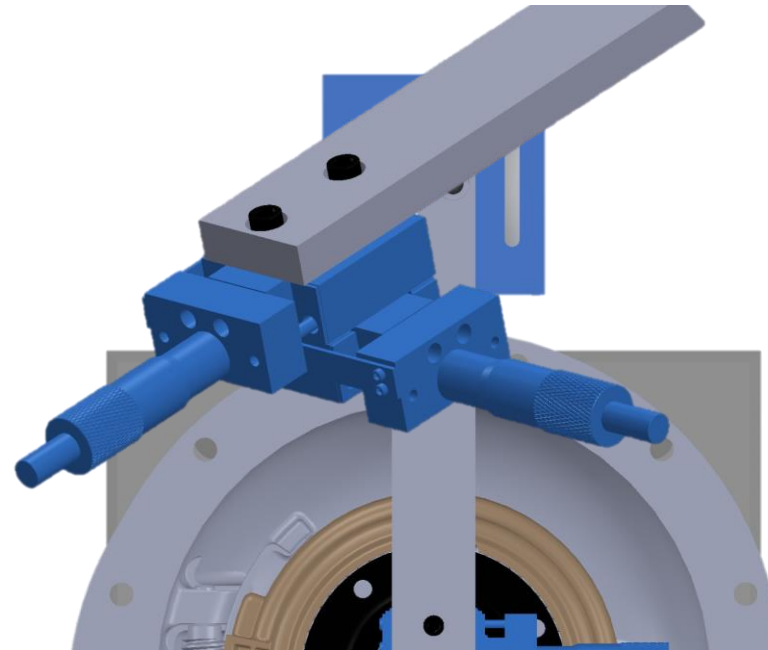

# Testing

- Two Laser Modules
- Tracking Two Blades at Once
- Reflective Tape for Receiver
- Two-Axis Adjustment for Calibration

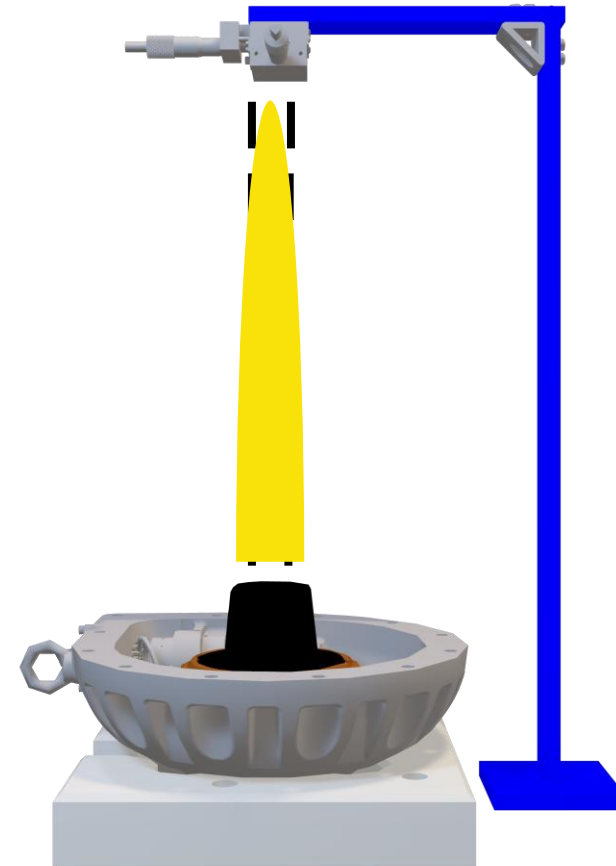

# Future Work

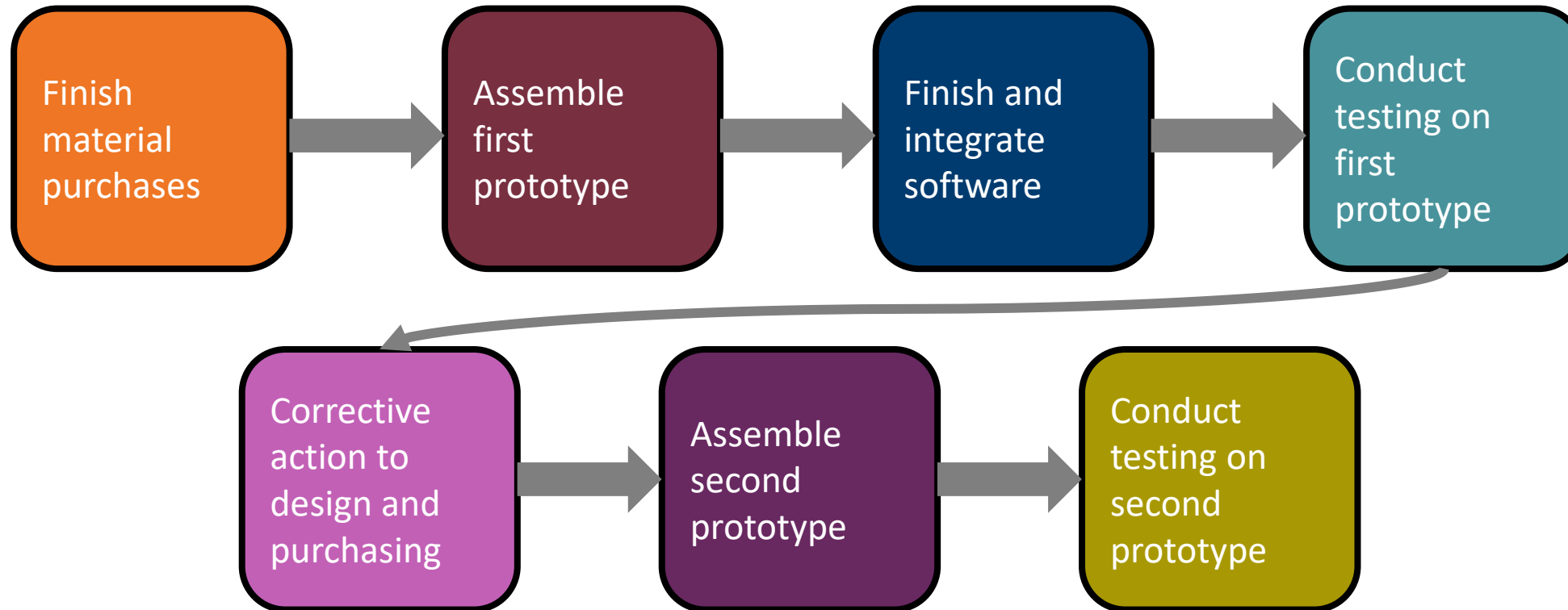

# Questions

