



FAMU- FSU College of Engineering
Department of Mechanical Engineering
Senior Design I: EML4551

WIRELESS INFRARED MONITORING SYSTEM

INTERIM DESIGN PROPOSAL

12/12/2014

Kenny Becerra	ECE	kb10j
Joseph Besler	ME	jkb11d
Michelle Hopkins	ME	meh09d
Alexander Hull	ECE	ah12r
Jonathan Jennings	ME	jwj08c
Nixon Lormand	ME	njl08c

Advisors
Dr. Hollis
Dr. Arora

SIEMENS

TABLE OF CONTENTS

Biography	v
Acknowledgement	vi
Abstract	vii
I. Introduction	1
II. Design and Analysis	4
A. Functional Analysis	4
1. Infrared Camera	4
2. Pan Tilt Module	5
3. Microcomputer	6
4. Wireless System	6
5. Power Management System	7
6. Weather Enclosure.....	10
7. Mounting Structure.....	10
8. Mounting Hardware.....	11
B. Design Concepts	12
C. Evaluation of Designs	13
1. Wind Loading Analysis	13
2. Ground Moment Calculation	14
3. Shear Analysis on Fasteners	14
D. Programming Needs & Control	15
III. Risk & Reliability Analysis	17
A. General	17
1. Pests	17
2. Manufacturer Quality	17
3. Improper Installation	17
B. Infrared Camera	18
C. Pan Tilt Module	18
D. Wireless System.....	18
E. Power Management System.....	18
F. Enclosure, Hardware, and Pole.....	19
1. Corrosion resistance	19
2. Impact resistance	19
IV. Environmental and Safety Issues & Ethics	20
V. Prototype and Procurement	21
VI. Project Management	24
A. Updated Project Schedule	24

B. Resource Allocation..... 24

C. Budget..... 25

D. Communications 25

VII. Conclusion 26

References..... 27

Appendix 1: Proposed Camera Locations 28

Appendix 2: Homer Analysis Data..... 29

Appendix 3: System Design Specifications 33

Appendix 4: FEM Mount & Component Analysis Results..... 50

Appendix 5: Prototype Specifications 51

Appendix 6: Complete Project Gantt Chart 54

TABLE OF FIGURES

Figure 1. System Targets.	2
Figure 2. System Diagram.	4
Figure 3. FLIR A310f Infrared Camera.	5
Figure 4. Axis YP3040 Pan Tilt Module, PS24 Mains Adapter, and Arm Support.	6
Figure 5. Tiger Versalogic Microcomputer, I/O Paddleboard, and Dual USB Cable.	6
Figure 6. Power Management System Schematic.	8
Figure 7. Ameresco Solar Panel, UPG 100Ah Battery, EcoWorthy MPPT Charge Controller.	8
Figure 8. Samlex Inverter, Traco Step-Down Converter.	9
Figure 9. Signaw Weather Enclosure.	10
Figure 10. Straight pole vs. Tapered pole.	11
Figure 11. U-bolt and Mounting Brackets.	12
Figure 12. Orientation 1, 2, and 3.	13
Figure 13. Wind Analysis on Solar Panel.	14
Figure 14. Shear analysis on selected .25 in cap screw.	15
Figure 15. Message Format.	15
Figure 16. Standard Command Set.	15
Figure 17. YP3040 digital dip switches and cable schematic.	16
Figure 18. Potential pest access points and nesting regions.	17
Figure 19. Project Schedule.	24
Figure 20. Daily Load Profile Input.	29
Figure 21. Solar Resource Input.	29
Figure 22. PV Panel Settings.	30
Figure 23. Battery Selection and Settings.	30
Figure 24. Optimization Results of 150 W Panel with 2 55 Ah Batteries.	31
Figure 25. Photovoltaic Analysis.	31
Figure 26. Battery Analysis.	32
Figure 27. System Charge and Discharge Analysis.	32

TABLE OF TABLES

Table 1. System Constraints.	1
Table 2. IBC2006 Code.	2
Table 3. FLIR Lens Calculations.	5
Table 4. Component Power Consumption.	7
Table 5. Naming Convention and Components.	13
Table 6. Drag Force and Components.	13
Table 7. Orientation vs Ground Moment.	14
Table 8. Conceptual Design Cost Breakdown.	22
Table 9. Prototype Budget Cost Breakdown.	23

BIOGRAPHY

Michelle Hopkins - Project Manager

Michelle is a senior in Mechanical Engineering completing her final year as a Co-op with Siemens Energy. She specialized in, and is currently working on, Thermal Systems. She is currently a founding brother of the FSU Chapter of Theta Tau. Michelle plans to accept a full offer from Siemens Energy at the conclusion of the spring semester.

Nixon Lormand - Mechanical Engineering Lead

Nixon is a senior in Mechanical Engineering completing his final year. He specializes in mechatronics and robotics. Nixon is a member of ASME, NSBE, and Theta Tau and runs a blog about a robotics project he is a part of. He also does robotics research for Dr. Moore at the National High Magnetic Field Laboratory.

Kenny Becerra - Electrical Engineering Lead

Kenny is a senior and is double majoring in Computer and Electrical Engineering. He is an active member of SHPE and IEEE. He specializes in programming and embedded system software. Currently, he has an offer from PG&E as an IT Developer. He is interested in going back for his Masters in Computer Engineering after spending some time in industry.

Joseph Besler - Procurement Chair

Joseph is a senior in Mechanical Engineering and specialized in Dynamics. He is the secretary for SAE and interned for US Patent and Trademark Office. Joseph hopes to begin his engineering career in spring by getting a full time offer.

Alexander Hull- Programming Chair

Alex is a senior in Computer Engineering. He has interned at National Institute of Standards and Technology as well as worked under Dr. Edward Jones on programming an automated grading program. Alex plans on attending graduate school for Artificial Intelligence after finishing his undergraduate degree.

Jonathan Jennings - Prototype Chair

Jonathan is a senior in Mechanical Engineering and specializes in mechanical design/simulation. He is a founding brother and current President of the FSU Chapter of Theta Tau. He has previously interned at the National High Magnetic Field Laboratory in their Research and Development Department. He would like to pursue a career in Automotive or Marine Design.

ACKNOWLEDGEMENT

We would like to acknowledge our sponsor, Siemens Energy Inc., for their donation and support of this project and the Senior Design program. James Sharp, specifically, has always been available for technical advising and deliverable review and has served as a great liaison. We would also like to thank our faculty advisors; Dr. Patrick Hollis and Dr. Rajendra Arora and the instructors of Senior Design; Dr. Nikhil Gupta, Dr. Scott Helzer, and Dr. Chiang Shih, all of whom have provided valuable feedback and advising. We would also like to thank Dr. Oscar Chuy for providing advisement on our pan-tilt and microcomputer integration. Lastly we would like to thank Dr. William Oates in advance for loaning his infrared camera for our prototype; this has allowed us the opportunity to produce a quality proof of concept prototype.

ABSTRACT

This Interim Design Report will serve as our interim conceptual design proposal for our Solar Powered Wireless Infrared Monitoring System. This project has been initiated and delegated to our Senior Design Team of Florida State University's Mechanical Engineering Program by Siemens Energy in order to investigate a more effective, simplified preventative maintenance technique incorporating the use of Infrared Technology. Siemens has expressed their interest in a conceptual design of a Wireless Infrared Monitoring system that will monitor fossil fuel power plant equipment for problematic operation. They wish for this designed system to ultimately reduce costs through replacement of existing thermocouples and vibration monitoring devices currently used for temperature monitoring and preventative maintenance.

The conceptualized system consists of five major subsystems: the Infrared Camera, the Pan Tilt Module, the Wireless Communication Module, the Power System, and the Mounting Structure. The Infrared Camera will survey the selected targets thoroughly, precisely, and without interfering with the equipment. The Pan Tilt Module will control the camera's position allowing it to target a wide range of equipment reducing the need for a large amount of systems. The Wireless Communication Module, consisting of a microcomputer and wireless adapter, will filter, package, and communicate the infrared data to the control room. The Power System will consist of an accurately sized solar panel, charge controller, battery, and inverter to properly power the system throughout the year making it self-sustaining. Finally, the Mounting Structure will consist of the pole, weather enclosure, and fasteners necessary to house, secure, and protect all the components from the elements. Each of these five major subsystems must be integrated correctly for each of their respective functions to contribute to final success of the system.

This report will first cover the project background and scope definition as given to us by Siemens Energy. It will then summarize our market selections for each of the above specified components along with our design concepts and analysis for the full system. A risk and reliability analysis will then follow along with environment, safety, and ethics issues in effect summarizing our concerns about the proposed design. Next our prototype design will be specified along with methods for procurement. Finally the project management section will conclude the report with our project schedule, future plans, and budget breakdown.

I. INTRODUCTION

Currently Siemens uses a large network of thermocouples and local vibration monitoring devices for data capturing of operating equipment. All of these thermocouples must be individually tapped to each location that needs to be measured. Thus, there must be thermo-wells drilled into/onto any piece of equipment that necessitates temperature readings. The thermocouples then must be wired all the way back to the control room in order to capture the temperature readings. All of these individual systems are invasive, costly, and complicated to implement. This current state of temperature monitoring at Siemens' power plants beckons for consolidation, simplification, and improvement. Siemens is interested in investigating a more simplified and effective preventative maintenance technique. Specifically, they are interested in exploring the use of infrared technology. [2] Thermal imaging cameras can see things the human eye cannot by sensing electromagnetic radiation in the infrared range of 9–14 μm . [3] These cameras can be utilized to monitor the temperature of operating equipment, enabling it to diagnose potential problems long before other traditional systems. [4] The cameras are also noninvasive and do not require equipment interference. Siemens Energy has initiated this project to explore incorporating this technology in a conceptual design of a Wireless Monitoring System to improve their preventative maintenance service. [2]

This project has been delegated to our team to find a plausible system solution to the following goal statement and 4 objectives. [2]

“Design a proposed complete system that can monitor a wide range of equipment for problematic operation.”

1. Decrease equipment interference on operating systems
2. Create cost savings through the elimination of need for numerous existing systems
3. Decrease manual work needed for preventative maintenance
4. Design a stand-alone system that does not consume any auxiliary power

The following table, Table 1, captures the design constraints set forth by Siemens.

Table 1. System Constraints.

Subject	Descriptor	Constraint
Location	Exclusively	Fossil Fuel Power Plants
Lifetime	At least	30 years
Monitoring	Type	Thermal Imaging, up to 300°C
Power	Source	Solar Harvesting
Battery Storage	At least	3 days
Communication	Wireless	300m
Communication	Protocol	HART
Compliance	Code	NERC, IBC2006
Weatherproofing	Rating	IP55
Movement	Range	360° in horizontal, 90° in vertical
System Cost	Maximum	\$20,000
Prototyping Budget	Maximum	\$3,000

Table 2. IBC2006 Code.

Seismic Loading	Occupancy Category III
	Site Class D
	$S_s = 0.41g, S_1 = 0.19g$
Wind Loading	$V_{3s} = 100$ mph
	Exposure C
Rainfall	5"/hr for 1 hr in a day
Ambient	0-110°F

Our approach is to properly design and write a complete specification for a Wireless Infrared Monitoring System that is an effective substitute of the current preventative maintenance techniques. The will be accomplished through a thorough, yet timely, market study of available components in order to select specific products to be integrated as a complete system. These products must operate efficiently and effectively while also interfacing seamlessly to accomplish the our goal statement and objectives. This is a challenge due to the plethora of technology available on the market today. The second phase of the project will be to create a proof of concept prototype as close to the specified design as possible.

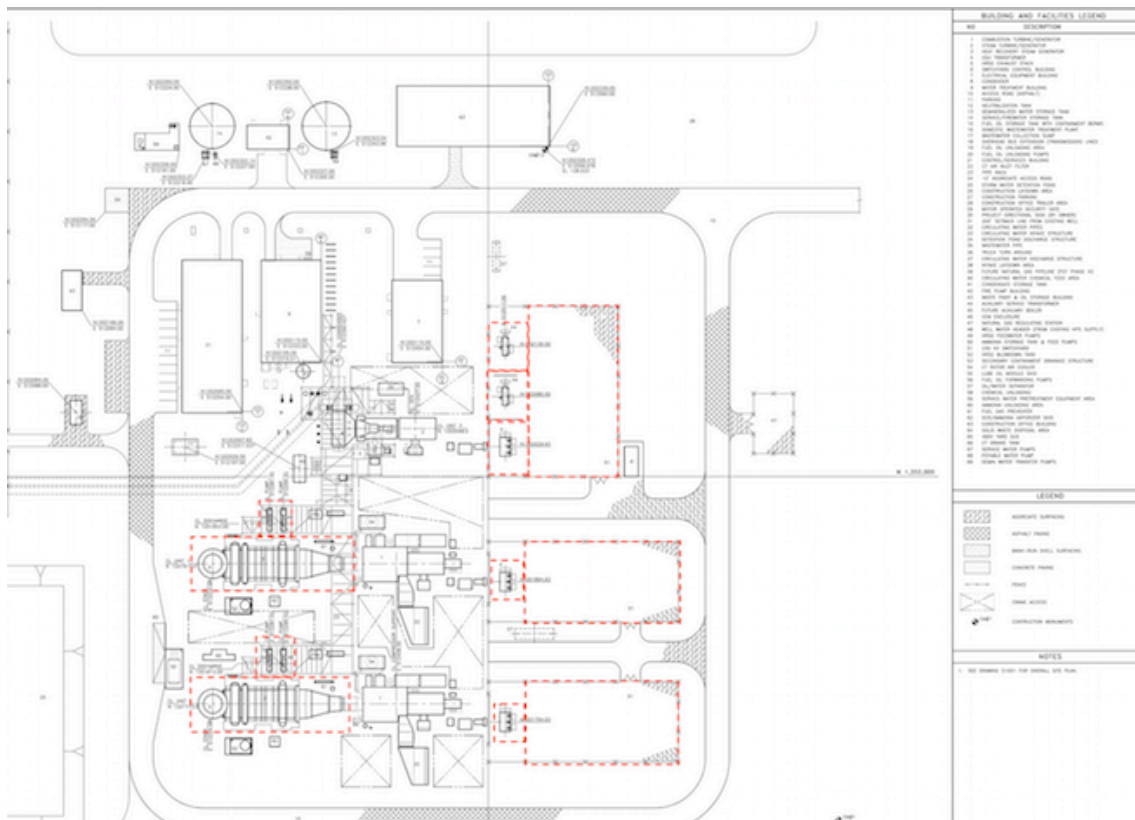

Figure 1. System Targets.

The testing site that will ultimately use this product, if it is deemed viable, is a 2x1 combined cycle power plant called Richard J. Midulla. It is owned by Seminole Electric and

provides about 810 MW to Hardee County, FL. [5] The plant is almost 15 years old and at the height of its maintenance period. Above in Figure 1 is a layout of the site provided to us by Siemens Energy. The boxed targets are the equipment of interest for our monitoring system; the Heat Recovery Steam Generator (HRSG), the Boiler Feed Water Pumps (BFP), Step up Transformers (GSU), Unit Auxiliary Transformers (UAT), and the Switch Yard. The Heat Recovery Steam Generator should be monitored for hot spots on the external casing indicative of insulation degradation from the hot gas path flow. The Boiler Feedwater Pump's motor and bearings should be monitored for overheating and pitting from extended use. The GSU and UAT's three power outlet bushings should be monitored for hot spots and short circuits indicative of a pre-explosive condition due to loss of insulation as well. Finally, the switchyard should be monitored for short-circuiting and hot spots as well. [2]

II. DESIGN AND ANALYSIS

A. FUNCTIONAL ANALYSIS

In order to accomplish our objectives under the constraints detailed above, a complete system was conceptualized and broken up into the following five major subsystems: Infrared Camera, Pan Tilt Module, Wireless Communication Module, Power System, and Mounting Structure. A block diagram of our system can be seen in Figure 2 illustrating our major subsystems and their interfaces with each other. The orange arrows indicate power, the grey indicates control, and the blue indicates data communication.

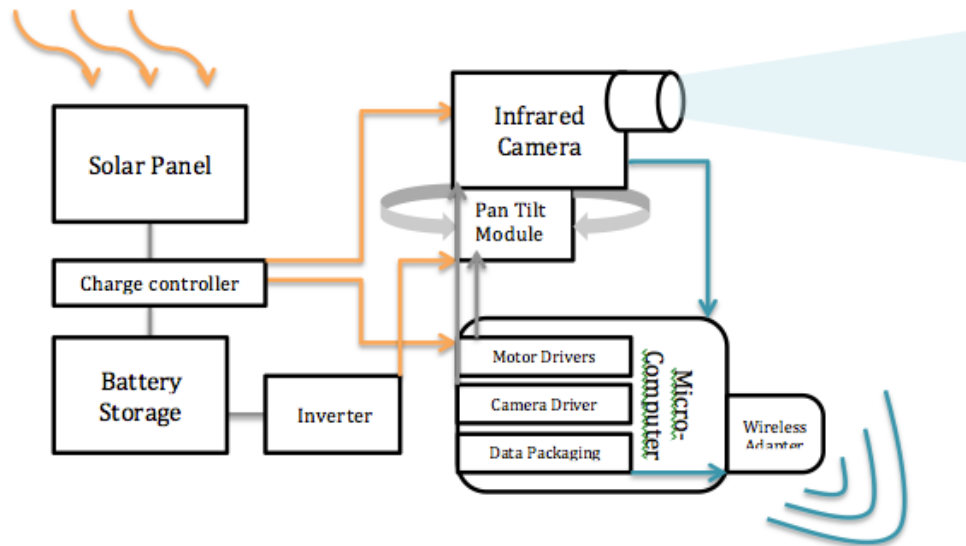

Figure 2. System Diagram.

The Infrared Camera will survey the selected target(s) thoroughly, precisely, and without interfering with the equipment (Objective 1). The Pan Tilt Module will control the camera's position allowing it to target a wide range of equipment and ultimately eliminating the need for numerous systems (Objective 2). The wireless network will monitor and communicate the data back to a control room, reducing the need for manual local monitoring (Objective 3). The Solar/Battery System will power the system making it self-sustaining (Objective 4). Finally, the Mount will support and house all of the above components. Each of these five major subsystems has an explicit goal that will contribute to the final goal statement. Please refer to Appendix 1, for our preliminary proposed system locations. These locations were selected in order to effectively monitor the most targets possible. These will be revised once a site visit is made in January to better assess system positioning.

1. INFRARED CAMERA

The FLIR A310f was selected as the Infrared Camera, as seen in Figure 2, due to its all-around performance specifications in power consumption, weather-proofing, and temperature readings. The FLIR A310f has a low power consumption of about 6W nominal and 24W max when utilizing its heaters. The FLIR A310f also is protected with an environmental casing rated IP 66 which was one of the rated cameras on the market.



Figure 3. FLIR A310f Infrared Camera.

This camera also gives an accurate temperature reading of ($\pm 2\%$) with a measurement temperature range of (32°F to 662°F) which exceeds the temperature constraint given. The FLIR camera was ultimately selected due the open market protocols and vast amounts of available product support. The FLIR camera's also come with a wide array of exchangeable lenses based upon your desired field of view. Table 3, below, is a table of the different lenses and their calculated field of views (horizontal, vertical, and instantaneous). This was another huge advantage of selecting FLIR because multiple lenses could be ordered and utilized on different systems depending on the targets being monitored. For standardization we recommend a 25° lens. [6]

Table 3. FLIR Lens Calculations.

Lenses	FOV (deg)	VFOV (ft)	HFOV (ft)	Spot Size (in)	IFOV (mrad)
6°	4.5	1.97	2.63	0.099	0.33
15°	11.25	4.94	6.58	0.246	0.82
25°	18.8	8.33	11.11	0.408	1.36
45°	33.8	15.53	20.7	0.735	2.45
90°	73	37.5	50	1.89	6.3

2.PAN TILT MODULE

The Pan Tilt Module selected for this design is the YP-3040 by Axis Communications as seen in Figure 4. It is designed as an optional accessory for Axis fixed network cameras with pan-tilt support. Even though it is preconfigured for several Axis fixed network cameras it uses the common Pelco-D protocol which can interface with the FLIR A310f. [7] [8] The YP3040 is said to be ideal for an inexpensive solution when fine adjustments to a cameras field of view are needed. It can pan 355° and tilt 90° . The Axis YP3040 also recommend several accessories, two of which we will be utilizing; the PS24 Mains Adapter and Mount. The Adapter will be used to step 120VAC down the 24VAC to power the camera. This adapter was chosen in order to protect and power the pan-tilt appropriately. The support arm will support and attach the pan tilt module to the pole securely.



Figure 4. Axis YP3040 Pan Tilt Module, PS24 Mains Adapter, and Arm Support.

3. MICROCOMPUTER

The Tiger VersaLogic, as seen in Figure 5, has been selected as our microcomputer because it meets the requirements needed for the application while also optimizing cost. VersaLogic has 30 years of industry-leading quality and service, offering a wide range of complete single board computers that are able to operate as a standalone system equivalent to a desktop computer, but in a smaller, more rugged and reliable package. VersaLogic's embedded computers are designed to operate under extreme temperatures, shock, vibration, and humidity [10]. The Tiger takes advantage of Intel's Atom Z5xx (Menlow XL) processor, which was designed specifically for embedded applications. Based upon Intel's 45 nm hi-k Metal Gate Silicon technology, the Z5xx series Atom chip offers high performance, industrial temperature operation and radically reduced power requirements. [10] The microcomputer is not expected to endure shock in the application. However, the Tiger board meets MIL-STD-202G specifications for mechanical shock and vibration for use in harsh environments. The camera will be able to connect to the standard on-board gigabit Ethernet port with network boot capability. The Tiger is compatible with a variety of popular 64 bit operating systems, including Windows, Windows Embedded, and Linux. Video features include advanced 3D graphics, high-definition video, integrated LVDS, and optional analog VGA support.

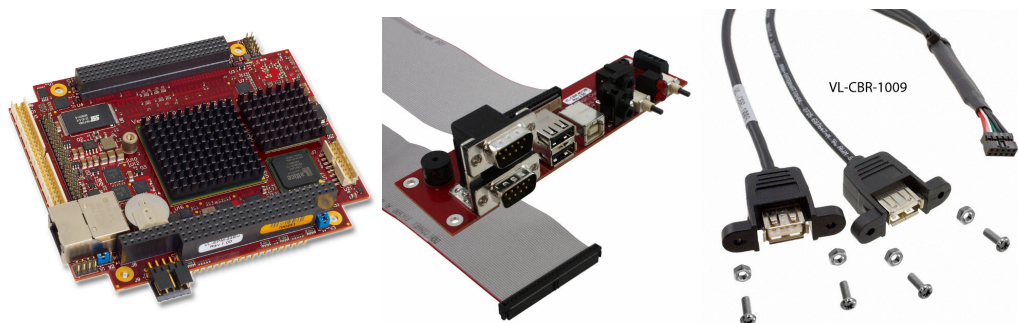

Figure 5. Tiger VersaLogic Microcomputer, I/O Paddleboard, and Dual USB Cable.

4. WIRELESS SYSTEM

The wireless system was designed to communicate between the camera and the control room via a Wireless Local Access Network using Wi-Fi technology. Although the sponsor expressed a desire to communicate with HART protocol, in order for us to be able to interface with the existing infrastructure, it was deemed unfeasible. There was no support

found for wireless communication between the selected microcomputer and wireless HART technology. This is contributed to the fact that HART is a current based communication protocol whereas most wireless adapters are voltage based. This is an exception that we are requesting to take and must be confirmed with our sponsor before we proceed with procurement. Instead, the following components were selected to comprise the wireless system; a router (TEW-813DRU), a USB access point (EW-7811Un), and an omni-directional antenna (TL-ANT2415D). The router will create the wireless network, the access point will be connected to the microcomputer giving it access to upload data to the network, and the antenna will provide the range necessary for data transmission to the control room. A minimum range of 300m was also dictated as a constraint distance. At a 300m range, the total loss the signal experiences is 90dB. This means that for communication to be possible the above components were selected to satisfy this equation while still being economic. [11]

$$\begin{aligned} \text{Loss} &\leq \text{Power transmitted}(Pt) + \text{Antenna Gain}(AG) - \text{Sensitivity}(S) = 90\text{dB} \\ \text{Router} \rightarrow \text{Microcomputer} &: 22\text{dB}(Pt) + 15\text{dB}(AG) - (-68\text{dB}(S)) = 105\text{dB} \\ \text{Microcomputer} \rightarrow \text{Router} &: 14\text{dB}(Pt) + 15\text{dB}(AG) - (-65\text{dB}(S)) = 94\text{dB} \end{aligned}$$

5. POWER MANAGEMENT SYSTEM

The solar/battery circuit was designed to power the complete system at site throughout the 30 year lifetime. This was done by modeling our system in HOMER 2 which utilizes the National Renewable Energy Laboratory's databases to optimize renewable systems. Images of the full analysis and optimization results can be found in Appendix 2. First, the decision was made to cycle our system on a 2 minute Power Cycle followed by a 10 minute Sleep Cycle, 5 times an hour. This is equivalent to an energy consumption of 300Wh/day. This decision greatly decreases total power consumption (compared to a 24 hour operation) and allowed for a more reasonable solar panel size and battery storage. Table 4 shows a power consumption breakdown of the two cycles. A 10% margin was used for the power cycle in case any extraneous power is consumed during start up/shut down of the components. A 50% margin was used for the sleep cycle due to the fact that the pan-tilt module and infrared camera did not provide a power consumption value for a 'sleep mode'.

Table 4. Component Power Consumption.

Module	Power Cycle	Sleep Cycle
Infrared Camera	9 W	--
Pan tilt Module	30 W	--
Microcomputer	6 W	1.05W
Wireless	1.5 W	1.5 W
Margin	10%	50%
Total	50W	5W
Length	2 min	10 min
Hours/day	4hrs/day	20hrs/day
Consumption	200Wh/day	100 Wh/day

These cycles were modeled in Homer, along with local insolation and temperature data from site. A system with a 150W panel with 2 Vision 12V 55Ah sealed lead acid batteries was the optimized result. Our power system, however, necessitates much more than just this

simplified set up. Below is a block diagram of the system circuit in Figure 6 with the appropriate power management components.

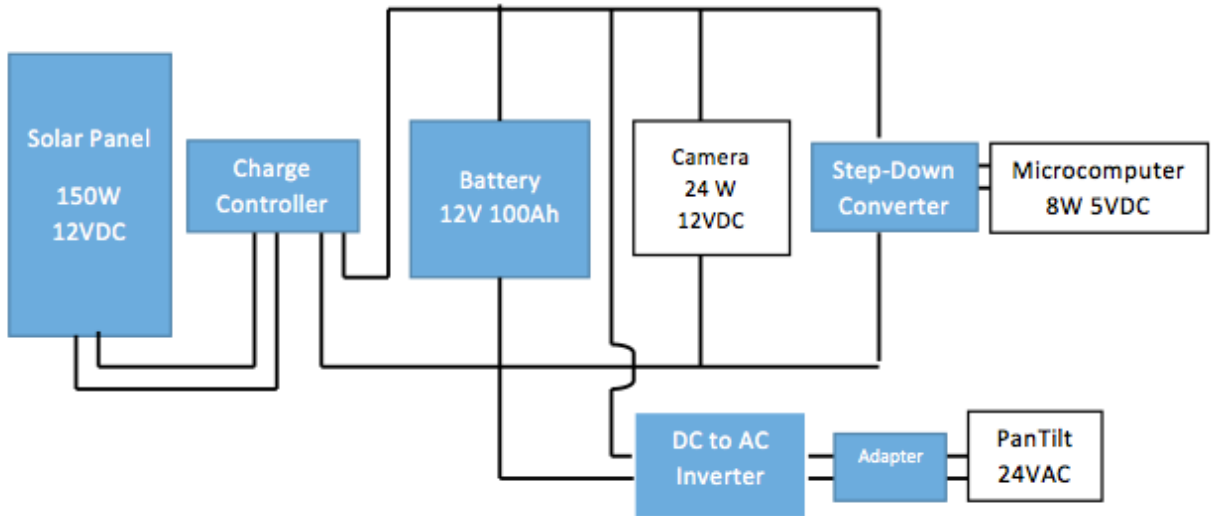

Figure 6. Power Management System Schematic.

An Ameresco 150 W Monocrystalline Panel was selected as our solar panel based on its efficient performance, high reliability, off-grid application, and quality certifications. A single Universal Power Group (UPG) 12V 100 Ah (UB121000) was chosen for the battery storage. It was decided to make our system voltage 12V in order to simplify our circuit and reduce the number of batteries necessary. The 100Ah of this UPG sealed lead acid battery will be enough storage to power the system through the lower lit months of winter and the rainy days of summer. This battery utilizes Absorbent Glass Mat Technology making it superior for performance and deep depth of discharge. The selected solar panel and battery can be seen in Figure 7, along with the selected charge controller.



Figure 7. Ameresco Solar Panel, UPG 100Ah Battery, EcoWorthy MPPT Charge Controller.

The charge controller selected for this design is a 20A EcoWorthy MPPT Solar Charge Controller. It uses the common 3-stage Pulse Width Modulation charge algorithm

and Maximum Power Point Tracking to efficiently charge the battery without cutting the solar panel's power production. This component was sized using Eq. 1.

$$A_{c.c} = \frac{P_{Panel}}{V_{battery}} + 25\% = 150 \text{ W} / 12 \text{ V} + 25\% = 15.6 \text{ A} \rightarrow 20 \text{ A} \quad (1)$$

The solar panel's open circuit voltage (22.2V) is less than the charge controller's max input voltage (42V), which will prevent the panel from burning out the charge controller. The solar panel's short circuit current (8.5A) is also less than the maximum charging current of the charge controller (20A) and the battery (30A) which will prevent the panel from causing the charge controller to fail and overcharging the battery. These are all necessary checks that must be made before properly selecting a charge controller. [13] The Ecoworthy Charge controller selected also has an LCD Display that shows the charging power and output status. This is a very functional feature when needing to know the status of the battery.

An inverter is needed in our circuit to convert the DC power supplied by the panel to AC power required by the Pan Tilt Module. An inverter's total wattage should always exceed the maximum appliance wattage (30W) by 25% to compensate for the converter efficiency. Additionally, if the load is classified as a motor or a compressor, it should have 3-5 times the appliance wattage added to the converter capacity in order to handle the surge current during the starting 3-6 seconds of the motor. A calculation of the inverter wattage can be seen in Eq. 2. [14]

$$P_{inverter} = (P_{pantilt} + 25\%) * 4 = (30 \text{ W} + 7.5 \text{ W}) * 4 = 150 \text{ W} \quad (2)$$

For this reason, and the fact that the battery voltage is 12V, A Samlex America 150 W inverter was chosen and can be seen in Figure 8. The inverter will invert 12VDC to 120VAC and will connect to the Axis Mains Adapter which will then transform the 120VAC to 24 VAC to power the Pan-Tilt.

A step down buck converter is also needed to convert the 12VDC system voltage to 5 VDC for the microcomputer. A TSR1-2450 Buck Converter from Traco Power will be utilized. It is 90% efficient, cheap, has an input of 6.5-32 VDC, and outputs 5 VDC at 1 A. It will be used to connect the battery to the microcomputer, which has a power rating of 6W at 1.2A with an additional 1.5 W from the wireless adapter. The step down converter can be seen in Figure 8 as well.



Figure 8. Samlex Inverter, Traco Step-Down Converter.

6. WEATHER ENCLOSURE

The purpose of the enclosure is to protect components susceptible to intentional and unintentional impact, overheating, tampering, and weathering. The enclosure should also remain relatively accessible for maintenance and monitoring purposes. To quantify these requirements, it is recommended that the enclosure be placed within 5' from the ground, be made of steel (preferably stainless), and have a locking feature. Being constructed of steel will allow for heat to be conducted away from the internal components when the internal space gets too hot. It will also allow the enclosure to withstand a reasonable amount of impact without failure.

The most important feature of the enclosure selected for the prototype in particular is cost. However, it is still highly desirable to select the enclosure most similar to the one used for the proposed design. Once again, the main purpose of our prototype is to utilize as many electrical components as possible that are the similar to the ones selected for the proposed design. That is, the microcontroller, pant-tilt, and camera are the most essential components to performing a proof of concept. Thus, with enough budget remaining the enclosure used for the prototype will be the same for both the proposed and prototyped designs.

The enclosure that meets set standards is the Signaw SCE-161410CHNF seen in Figure 9. This enclosure is a carbon steel box that is 16in x 14in x 10in and has an internal and external ANSI 61 grey powder coating for improved corrosion resistance [18]. In summary, this component meets all criteria set forth in the Design Concepts section.



Figure 9. Signaw Weather Enclosure.

7. MOUNTING STRUCTURE

The mounting structure selected for the system must be tall enough to view appropriate selected targets. The structure must also be strong enough to support the weight of all of the components and withstand 150 MPH wind imposed on itself and each component being mounted to it. The mounting structure should also be able to withstand reasonable amounts of intentional or unintentional damage by personnel and small vehicles such as forklifts. More concretely, it is recommended that the structure be a pole of at least 15ft height, have a round tapering cross section, and be constructed of pre-stressed concrete.

The range of target heights dictates the selected height of the pole. The step up transformer has a height of 15ft, the BFP has a height of 10ft, and the HRSG has a height of 100ft. There is a noticeably large difference between the HRSG and other target heights. Thus, it was decided to select two mounting structures; one for monitoring the HRSGs and one to monitor everything else. Since the majority of the components were within 15ft above grade, selecting a mounting structure to monitor these shorter targets became first priority.

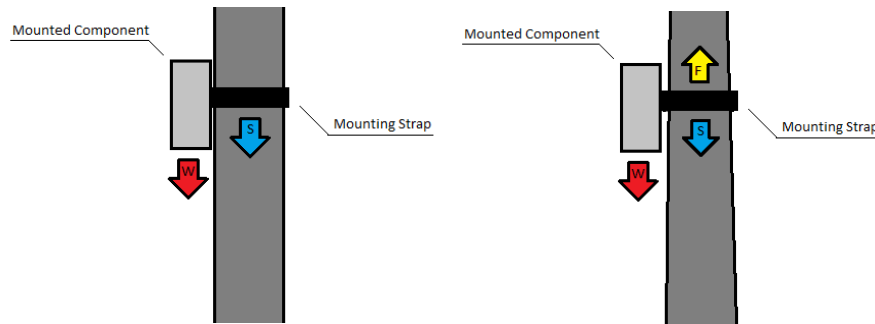

Figure 10. Straight pole vs. Tapered pole.

Having a round cross sectional area allows the pole to disperse stress more evenly than a square one. This is due to the stress concentrating nature of corners. Also, the tapering cross section provides two advantages. The first is that tapering reduces the net weight of the pole. Furthermore, it reduces the weight of the pole with respect to height, which in turn reduces the loading on the descending layers and reduces the moment induced on the foundation of the pole also known as the Ground Moment. The second benefit of a tapering pole is that components utilizing binding hardware exhibit a self-tightening effect. That is, if the mount is installed with too little preloading, the components have the tendency to slip down the pole. If the pole is straight as opposed to tapered, small vibrations and load changes on the components allow the loose mounts to slide all the way to the ground as seen in Figure 10. With a tapered pole, a loose strap will increase its tension as it slides down the pole as seen in Figure 10.

Lastly, having a pole made from concrete allows the pole to exhibit reduced deflection in comparison to other common pole materials such as aluminum or steel. This lack of deflection (or high stiffness) helps ensure that the camera remains focused on its target and thus, maintains the overall accuracy and consistency of the monitoring subsystem.

The pole selected to meet these requirements is the Utility Structure Incorporated pole and is specified in in the Appendix 3. This pole meets all design specifications set forth previously. The cost of this pole selection when compared with other products and materials is considerably higher at about \$2,100 per unit. The larger costs associated with this pole can be attributed to the central location of manufacturer, Canada. The main reason for the selection of this pole is because it meets our design requirements and still falls within our budget. However, a preferable vendor will be sought out to further optimize the cost effectiveness of our system.

The pole selected for the prototype is a much smaller, more simplified version of the pole selected for the prototype. It is best to have the pole be constructed of something other than concrete, for mobility sake. It is also ideal to select a pole that will allow for all the components to remain highly accessible for monitoring and testing purposes. That is, a shorter pole is best for testing purposes. Both of the previously mentioned criteria effectively lessen the cost required to order a prototype pole and thus improve the team's ability to produce a more valid proof of concept. The current pole selected to meet this criteria is a 6ft 4in carbon steel pole from McMaster.

8. MOUNTING HARDWARE

The mounting hardware selected for this system is responsible for fixing the necessary components to the mounting structure. This is accomplished by meeting all

loading requirements dictated by component weights and drag forces discussed later in the Evaluation section of this report. Furthermore, relevant fasteners are preloaded to provide enough tension to ensure that mounted components remain fixed to their proper location on the pole. The size of the fasteners was selected such that they are large enough to resist failure from shear and tension caused by component weight and expected wind loads at 150 MPH. All washers used increase the loading area of the fastener or dampen the effects of vibrations. In general, increasing the effective surface area of the fastener can be accomplished by selecting a larger outer diameter washer. In contrast, vibration dampening can be achieved by selecting an appropriate lock washer. Both of these washer types help to ensure that the fasteners maintain the appropriate preloading and tension over extended periods of time. Only 0.25in stainless steel lock washers have been required for system construction at this time.

Mounting kits are selected and designed to accommodate stock mount patterns manufactured on each of the selected components. Furthermore, the mounting kits focus on the interfaces between the enclosure and pole, solar panel and pole, camera and pan-tilt module, pan-tilt mounting arm and pole, and pole and foundation. Some selected mounting components are seen in Figure 11.

The hardware utilized for the prototype should be very similar, if not the exact same to the hardware used for the proposed design. This will allow for testing of longevity and load bearing properties of the hardware to help ensure that the lifetime of the overall system meets the 30 year requirement set forth by Siemens



Figure 11. U-bolt and Mounting Brackets.

All specifications for the recommended design components can be found in Appendix 3.

B. *DESIGN CONCEPTS*

When selecting the above components, it is important to consider their mounting location on the pole. The selected components and contents are broken down in Table 5 below. It was determined that Component 2, the enclosure, always remain near the hand hole located 3ft above grade. Placing Component 2 at this location ensures that the power and data cables used in this system remain protected. Protection of these cables is considered important for reasons discussed later in the reliability and risks section of this report. Components 1 and 3 were determined to be best suited at or near the top of the pole. Some sample configurations of interest are shown below in Figure 12.

Table 5. Naming Convention and Components.

COMPONENT	SUBSYSTEM(S)
COMP1:	Pan-Tilt, Mounting, & Camera
COMP2:	Enclosure, Mounting, & Contents
COMP3:	Solar Panel & Mounting

In summary, Orientation 1 was determined to be the optimal solution. This orientation accounts for the weight and wind loading effects for Components 1 and 3. This ensures that the pole and fasteners selected will be able to withstand the maximum loads possible. The only variation that would increase the loading considerably would be moving Component 3 to the top of the pole which as mentioned earlier is unadvised. The actual orientation of the system will be based on the location of the targets that will be monitored and installation location of the system.

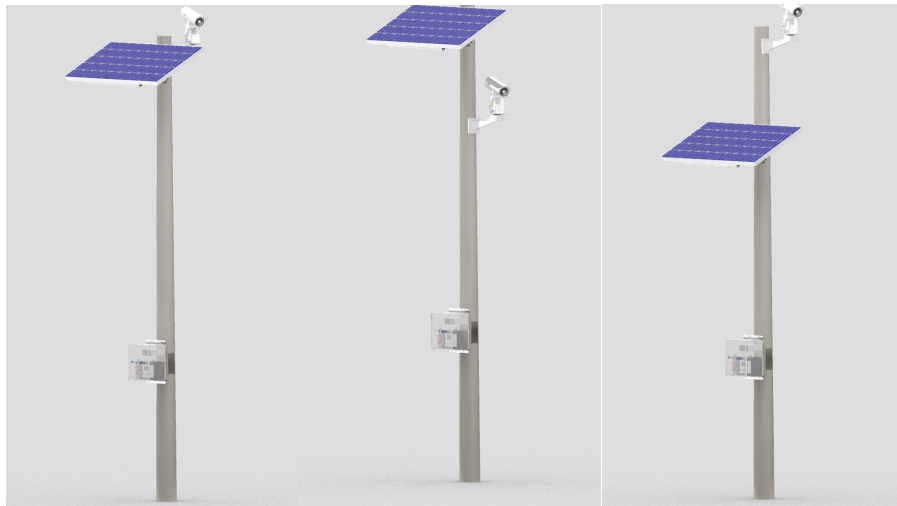

Figure 12. Orientation 1, 2, and 3.

C. EVALUATION OF DESIGNS

1. WIND LOADING ANALYSIS

The resulting wind loading analysis can be found in Table 6.

Table 6. Drag Force and Components.

COMP1	COMP2	COMP3
68.39 lbf	76.71 lbf	225.22 lbf

These values were determined utilizing the FEA software, COMSOL in a general setup shown in Figure 13. Each of the 3 components detailed in the previous section were oriented such that their largest surface was acted upon by the wind. The projected areas (EPA) of each component can be found in Table 4-3A in Appendix 4. It should also be noted that the solar panel was the only component that was not oriented normal to wind flow. This is due to its actual 27 degree orientation. Having the solar panel tilted at this

angle allows the panel to receive the nominal amount of insolation as dictated by this particular site location. The nominal wind velocity was assumed to be a 150MPH with the flow being parallel to the ground. The velocity of 150 MPH was used based on wind velocity charts commonly found in utility pole catalogues. Assuming this nominal wind speed also provides a 1.5 gust (safety) factor for the 100MPH wind loading requested by Siemens.

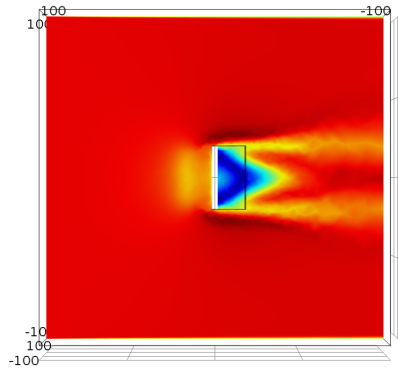

Figure 13. Wind Analysis on Solar Panel.

2. GROUND MOMENT CALCULATION

The Ground Moment helps to characterize and select a pole for mounting. Furthermore, each individual component, including the pole itself contributes some to the net moment on the structure at the ground. Table 7 shows the wind loading contributions of each of this project’s selected components on the ground moment. The orientations mentioned in this table are discussed previously in the Component Orientations section of this report.

Table 7. Orientation vs Ground Moment.

ORIENTATION	COMP1	COMP2	COMP3	NET M (ft*lbf)
Orientation1	12 ft.	3 ft.	15 ft.	4429.13
Orientation2	15 ft.	3 ft.	15 ft.	4634.30
Orientation3	15 ft.	3 ft.	12 ft.	3958.62

In summary, the orientation that results in the largest ground moment is Orientation 2. This is due to the combined drag force of the pan-tilt module, camera, mounting arm, and solar panel all of which are fixed to the top of the pole. Utilizing this calculation, Orientation 3 would be deemed most suitable for design. However, this will be discussed more in the following sections.

3. SHEAR ANALYSIS ON FASTENERS

The shear force on some of the mounting hardware selected was tested to find some expected modes of failure. This shear testing set up can be seen in Figure 14. A main concern was the shearing of fasteners. The original fasteners selected were 0.5in cap screws. After some shear analysis in Mathcad it was determined that these could potentially be too large as they had a safety factor of over 100. The secondary selection of a 0.25in cap screw (Figure 14) proved more universal as it can be used on the majority of the mounting

components. The 0.25 in cap screw also had a shear safety factor of 24 which should still permit it to last the required 30years baring static and dynamic wind loads.

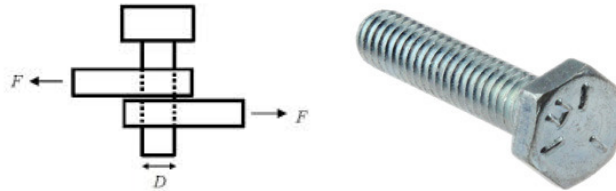

Figure 14. Shear analysis on selected .25 in cap screw.

D. PROGRAMMING NEEDS & CONTROL

The YP3040 pan tilt module will be controlled using either a Pelco D/P or AD/AB protocol. Even though it is preconfigured for several Axis fixed network cameras it uses the common Pelco D protocol. The Pelco D protocol is used between matrix switching systems and receivers/drivers. The format of the message can be seen in Figure 15. The message sent is dependent on the values assigned to each bit. The check sum is bit 8, the sum of the payload bytes 2 through 6 in the message. The standard command set can be seen in Figure 16 [8].

Byte 1	Byte 2	Byte 3	Byte 4	Byte 5	Byte 6	Byte 7
Synch Byte	Address	Command 1	Command 2	Data 1	Data 2	Check Sum

Figure 15. Message Format.

	Bit 7	Bit 6	Bit 5	Bit 4	Bit 3	Bit 2	Bit 1	Bit 0
Command 1	Sense	Reserved	Reserved	Auto / Manual Scan	Camera On / Off	Iris Close	Iris Open	Focus Near
Command 2	Focus Far	Zoom Wide	Zoom Tele	Down	Up	Left	Right	Always 0

Figure 16. Standard Command Set.

As seen in Figure 17, the pan tilt module consists of two sets of 8 digital DIP switches that are located on each side of the module, allowing 255 different switch combinations. To access the dip switches, the 4 side panel mounting screws must be loosened to remove the panel. The left side of the module has the 8 dip switches that allow the user to change the protocol, bit rate, and the terminal resistance. The right side of the module contains the 8 dip switches that are used to select multiple unique addresses when connecting several units in a series through a multi-channel video server.

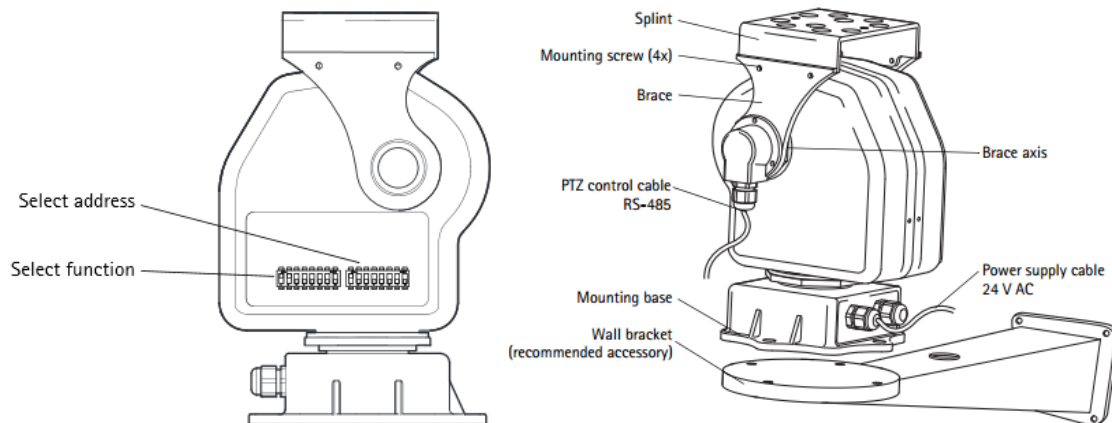

Figure 17. YP3040 digital dip switches and cable schematic.

The YP3040 uses the RS-485 standard to communicate and control the pan tilt module as seen in Figure 17. A RS-485 network allows communication at distances up to 4000 feet. Data is transmitted differentially on two wires twisted together called a half-duplex, plus a ground wire [9].

The control of the pan-tilt and the camera will be programmed from the microcomputer along with the proper data packaging code. The FLIR software that comes with the A655 camera is going to be utilized in the software development to filter and analyze the data from the camera. File sharing between the microcomputer and the control room will be handled by a script that will be ran in the background of the control room computer which will allow the computer to autonomously access the designated files from the microcomputer. An alternative to using file sharing (for instances when the microcomputer uses a non-Windows OS) is an FTP/HTTP server can be loaded to the control room computer, and the file transfer can be facilitated through the server. All of the software development necessary for this project will be occurring next semester during the prototyping stage. This is because the presence of the VersaLogic microcomputer is necessary for compiling and debugging the code. Our goal is to have autonomous pan-tilt, camera control and successful wireless transmission of infrared data. Our secondary goal is to have some sort of GUI to filter and monitor this data for irregularities.

III. RISK & RELIABILITY ANALYSIS

A. GENERAL

1. PESTS

Pest can reduce the longevity and performance of this system. Nesting can cause harm when considering the pan-tilt arm, solar panel, enclosure, or hand hole of the pole. Nesting on the pan tilt arm and/or camera can obstruct the camera lens and constrict the motion of the pan-tilt module. A nest constructed on the solar panel, will block a considerable amount of sunlight. Also, a pest nesting within the enclosure can cover important electronics with nesting debris and chew away at the equipment. If allowed to accumulate, the debris will limit conductivity and reduce heat transfer, which will make the system fail. Furthermore, some of the damaged items will require replacement if chewed on or allowed to overheat.

Some of the problems mentioned previously are shown in Figure 18. The potential problems can be easily accounted for through proper installation and selection of high weather rated equipment. That is, if the covers on the hand holes are left loose, pests can climb into the post and chew on valuable cables. Also, if the enclosure has punch-outs or is poorly sealed, pest can damage the internal components. However, this is not the case with the exposed components of this system having an IP rating of 66 and a NEMA rating of 4 as discussed previously.

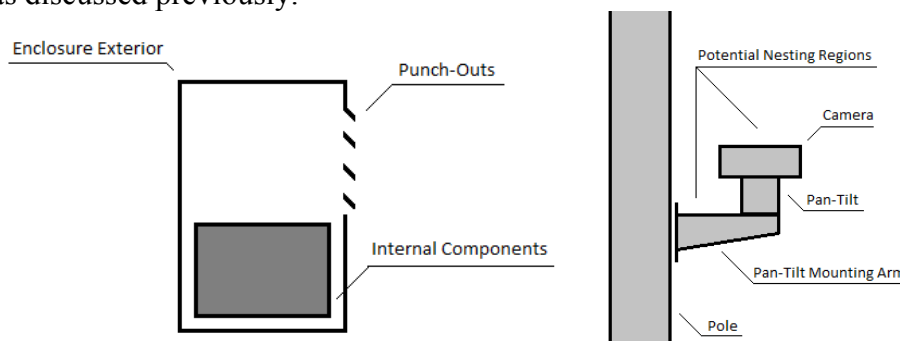

Figure 18. Potential pest access points and nesting regions.

2. MANUFACTURER QUALITY

Manufacturers develop many processes to ensure product quality. However, manufacturing processes are not 100% effective and sometimes produce faulty products. This defect probability can be further reduced with a good amount of product inspection prior to its installation.

3. IMPROPER INSTALLATION

Building off of the previous sections, improper installation can furthermore, result in premature product failure. For example, installing the foundation of the pole improperly will result in fracture and/or tipping of the mounting structure. In general, it should be ensured that all installation guidelines are followed and necessary precautions taken.

B. *INFRARED CAMERA*

There may be some challenges at implementing the Infrared Camera into our prototype design. Some problems may arise when attempting to take accurate temperature readings of targets since multiple targets with different emissivity. The configuration of the camera to focus on targets at varying distances may be challenging. Also if each target is made of different materials they would have different emissivity which would make it difficult to obtain correct temperature reading of each object. Currently, we hope to be able to calibrate the camera with an average emissivity value of the 5 targets and plot the differential temperature. This will show us any abnormal rises and give us more accurate information of how the equipment is operating rather than arbitrary temperatures.

There is also a large risk of testing the FLIR A655 camera outside since it has a low International Protection Rating of (IP30). This will be mitigated with either monitored testing during good weather days only for short periods of time or separating the power system and monitoring system and testing each separately. The former is preferred, as it would give us more cohesive results.

C. *PAN TILT MODULE*

The transmission between the pan tilt module and the camera will not work if the camera uses a different protocol and bit rate than the module. If it is not possible to configure the pan tilt module to match the protocol of the camera, then a direct connection from the microcomputer to the pan tilt module is required. Half-duplex wiring requires attention to turn-around delay which is a function of baud rate. Too much or too little turn-around delay can cause a delay. The half-duplex wiring does not require the use of the ground wire. However, over a distance of hundreds or thousands of feet there can be very significant differences in the voltage level of "ground". This RS-485 network should be able to maintain correct data without a difference of -7 to +12 Volts since the RS-485 network will not be more than 30 feet and there is only one module in the connection. There is only one ground so data would not be lost and the port itself should not be damaged [9].

D. *WIRELESS SYSTEM*

As a whole the wireless system is meant to provide preventative maintenance to fulfill "Reliable Operation" which is defined by NERC as "Operating the elements of the bulk-power system within equipment and electric system thermal, voltage, and stability limits so that instability, uncontrolled separation, or cascading failures of such system will not occur as a result of a sudden disturbance or unanticipated failure of system elements." [13] This means that the system must be safeguarded against failure in order to properly ensure that unanticipated failures do not occur. One issue with the designed system is rain; since the connection from the computer to the router is close to the communication limit it is possible to experience loss of connection in extremely heavy rain. NERC requires protection of data and access management. Making the communication one-directional prevents tampering with the data from the microcomputer and prevents the need to monitor user access on the microcomputer.

E. *POWER MANAGEMENT SYSTEM*

When doing grid -tie photovoltaic systems it is common to see Fuse panels. This is because these systems are usually large, and the solar panel combined with the

battery/generator/power grid is frequently switched between each other. Because of this switching the fuse panel is installed for safety and for circuit stability. When doing off-grid systems the fuse panel is optional, except when doing DC-AC conversion, however most DC-AC converters already have fault detections installed. In essence, since this is a small system with low levels of amperage and voltage, as well as only having 1 component requiring AC, the necessity of purchasing a DC distribution fuse panel can be considered low. However individual fuses are going to be considered in order to protect certain, expensive, components during the prototyping stage.

The maintenance of the battery is dictated by 3 factors; the amount of cycles the battery goes through in its lifetime, the depth of discharge of the battery per cycle, and the environment of the battery. The battery chosen is a deep cycle lead acid battery, so it is a robust battery (can handle high temperature and weather changes) with large amount of cycles for its lifetime. There are currently 2 variables missing to find the overall maintenance of the battery; the frequency and the depth of discharge per cycle. Because of the variability of the sun it is difficult to estimate how often the battery will be in a state of charging (storing energy) or discharging (providing energy). Also because of the volatile nature of solar power, it is hard predict the depth of discharge per cycle (going through both charging and discharging is considered 1 cycle). Power analyses simulation through Homer is able to make predictions on possible max depth of discharges, and approximate cycles per day, but combining these factors together may not provide a realistic maintenance schedule for the battery, considering too many approximation are taking place before arriving to the final product. The proof of concept of the battery will be able to accurately give data regarding the daily cycles of the battery and an average depth of discharge per cycle. Even taking into account different solar insolation levels of the locations, making comparisons between homer simulation data, and realistic data, we can better approximate battery maintenance when the actual application design is used. However the current life of the batter is specified as 10 years, therefore at a minimum would need to be replaced 3 times.

F. *ENCLOSURE, HARDWARE, AND POLE*

1. CORROSION RESISTANCE

The materials of the expose components play a large role in the reliability and risk of the complete systems. All fasteners, housing, and mounting components with respect to mounting, are stainless steel. Those that aren't stainless steel are externally coated with ANSI 61 grey paint. This selection of paint improves the corrosion resistance of the component dramatically.

2. IMPACT RESISTANCE

When considering the reliability of the completed system, impact resistance must be considered, more specifically, intentional and unintentional impact resistance from personnel and heady duty equipment (forklifts). Material and geometry are a prime determinant of a component's structural integrity. Further research and simulations will be done to determine the reliability of each components impact resistance.

IV. ENVIRONMENTAL AND SAFETY ISSUES & ETHICS

Due to the fact that our system is self-sustaining and non-invasive, there is little to no environment impact. However, it bears mentioning that care needs to be taken in disposal of the batteries when replaced. Lead Acid Batteries must be recycled so the used batteries either must be shipped back to the manufacturer or taken to an appropriate recycling establishment.

Other safety issues include personnel safety while prototyping. We must practice safe electrical safety while wiring and testing our Solar/Battery Circuit. This also applies to creating a safe electrical circuit to avoid any short-circuiting or pre-explosive conditions.

It also must be considered that future maintenance on this system, when implemented, must be performed under the normal safety regulations of the power plant. This should cover the dangers any personnel might experience (ladder climbing, head protection, etc.) while servicing our system.

Lastly it should be mentioned that we are all undergraduate engineers who have not yet taken our fundamental engineering exam or received our degrees so although we have practiced a good code of ethics and sound engineering practices, our work cannot be certified.

V. PROTOTYPE AND PROCUREMENT

The prototype design should be a slightly scaled down version of the proposed Siemens design. Many of the components that were chosen for the prototype design are the same components that were recommended for Siemens proposed design. This was done in order to accurately test the integration of the components, as well as to provide software that Siemens would be able to implement in their system operation. As a whole, the prototype should be able to take autonomously take infrared pictures of 5 ‘targets’ within at two-minute interval and wirelessly transmit infrared images and/or infrared data to the ‘control room’. The prototype should finally be powered through the installed solar power and battery storage.

Since the A310f camera is too costly to purchase with our prototype budget, a different camera will be used for our prototype. For our prototype design, Dr. Oates has kindly agreed to loan us his FLIR A655 Science Grade Infrared Camera. This camera has many similar features to the FLIR A310 with a similar power consumption (24W with heater), accuracy ($\pm 2\%$), and temperature reading (32°F to 662°F). The FLIR A655 lacks an environmental housing and only has a weatherproofing of (IP30) which may hinder outside testing. Rather than Hart protocol, the prototype's wireless communication will be accomplished through Wifi by the use of a wireless USB adapter (Edimax EW-7811un) attached to the microcomputer and a wireless router (Trendnet AC1750). The transmission distance will be reduced and the antenna eliminated for the sake of budget constraints. The prototype will utilize a 150 W Renogy solar panel instead of the Ameresco panel due to budget constraints as well. This Renogy panel has very similar specifications as the Ameresco panel specified in the design and should be sufficient for proof of concept. Finally, the pole and weather enclosure will be downgraded for budget's sake. This is due to the fact that system analysis and testing will be mainly performed on the electrical and software components of the system for proof of concept in lieu of the mechanical performance. Table 8 and 9 on the following pages are a breakdown of the proposed design components and the prototype components respectively.

Table 8. Conceptual Design Cost Breakdown.

Component	Selection	Cost
Infrared Camera	FLIR A310f	\$10,000.00
Pan Tilt	YP-3040	\$448.44
AC Adapter	Axis PS24 Adapter	\$165.00
Pan Tilt Arm	Axis Communications	\$40.00
Microcomputer	Versallogic	\$981.00
Microcomputer Ports	VL-CBR-5012	\$66.00
Microcomputer Adapter	VL-CBR-1009	\$33.00
Ethernet Cable	14' Belkin	\$3.13
Router	Trendnet AC1750 (TEW812DRU)	\$107.87
Antenna	TP-Link (TL-ANT2415D)	\$49.99
Access Point	Edimax EW-7811un	\$8.18
Solar Panel	Ameresco 150 W	\$415.00
Charge Controller	20 A MPPT	\$105.00
Batteries	UB121000	\$185.00
Inverter	Samlex 150 W PST Series	\$115.00
DC Converter	TRACO	\$8.00
Mounting Pole	USI HA-220-D-1-PG-80	\$2,100.00
Lock Washer 1 (50)	McMaster 91007A632	\$9.38
Hex Nut 1 (50)	McMaster 9811A029	\$6.46
Cap Screw 1 (25)	McMaster 93190A542	\$6.40
Weather Enclosure	Signaw SCE-161410CHNF	\$134.00
Mounting Kit 1	L-COM HGX-PMT30	\$55.00
	Total	\$15,042
	Budget	\$20,000
	Extra	\$4,958

Table 9. Prototype Budget Cost Breakdown.

Component	Selection	Vendor	Cost
Infrared Camera	A655sc	Dr. Oates	\$0.00
Pan Tilt	YP-3040	Surveillance-Video	\$448.44
AC Adapter	Axis PS24 Adapter	Surveillance-Video	\$135.44
Pan Tilt Arm	Axis Communications	Surveillance-Video	\$45.55
Microcomputer	Versalogic	Digi-Key	\$981.00
Microcomputer Ports	VL-CBR-5012	Digi-Key	\$66.00
Microcomputer Adapter	VL-CBR-1009	Digi-Key	\$33.00
Ethernet Cable	14' Belkin	Walmart	\$3.13
Router	Netgear RangeMax WNR1000	Walmart	\$38.42
Access Point	Edimax EW-7811un	Walmart	\$8.18
Solar Panel	Renogy 150W Mono	Renogy-Store	\$239.99
Charge Controller	20 A MPPT	Eco Worthy	\$105.00
Batteries	UPG UB121000	batteryclerk	\$185.00
Inverter	Samlex 150 W PST Series	altE Store	\$111.43
DC Converter	TRACO	Newark	\$7.33
Mounting Pole	Steel 6ft	McMaster	\$61.00
Lock Washer 1 (50)	91007A632	McMaster	\$9.38
Hex Nut 1 (50)	94819A043	McMaster	\$6.46
Cap Screw 1 (25)	93190A542	McMaster	\$6.40
Weather Enclosure	SCE-161410CHNF	Signaw	\$134.00
Mounting Kit 1	HGX-PMT30	L-COM	\$55.00
Total			\$2,680
Budget			\$3,000
Extra			\$320

All prototype specifications for components differing from the proposed design can be found in Appendix 5.

VI. PROJECT MANAGEMENT

A. UPDATED PROJECT SCHEDULE

With the submission of this report, we conclude the first half of this project. The project schedule below illustrates the plans for next semester and what will be occurring during the month of December. To note, next week we will have our interim design review meeting with Siemens Energy to gather feedback on our proposal and get the go ahead to begin procuring. Our purchase orders will be complete by December 12th to ensure that all materials are received in time for prototyping next semester. We will be visiting site on January 5th right before we reconvene as a team on January 7th. A component lead-time of 45 days was incorporated into the schedule in order to safely account for the delay of receiving hardware. This should be a sufficient amount of time to update our project scope and begin software development before assembly of the prototype. After all components are received and the software is completed, our prototype will be assembled, tested, and refined before final analysis.

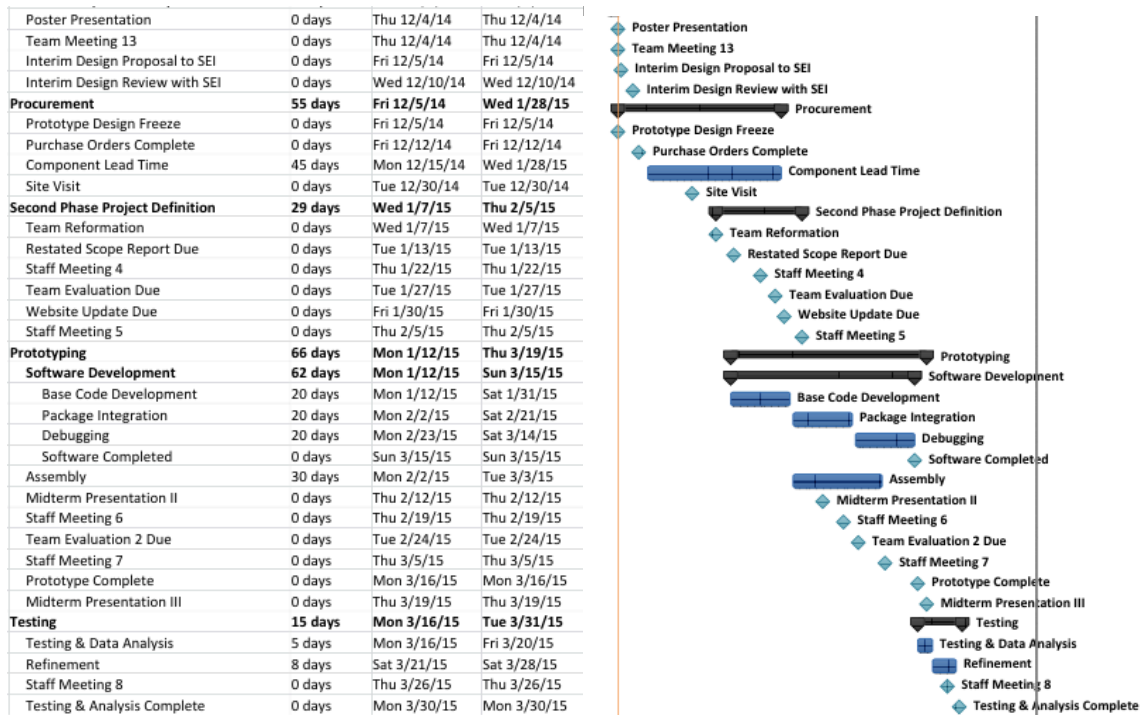

Figure 19. Project Schedule.

B. RESOURCE ALLOCATION

Joseph Besler, as the Procurement Chair, is responsible for all purchase orders and receiving of materials. Software Development will be led by Alexander Hull, our Programming Chair, and Nixon Lormand, our Mechanical Engineering Lead. Prototype assembly and testing will be led by Jonathan Jennings, our Prototype Chair, and supported by Kenny Becerra, our Electrical Lead, who will be responsible for the electrical circuitry. Michelle Hopkins, the Project Manager, will oversee all of these efforts and is responsible for all reports, presentations, and meeting proceedings.

C. *BUDGET*

Referring to Tables 8 and 9 above in Section IV, we currently have a design system cost of \$15042. This is about \$5000 less than the constraint budget of \$20,000. We are tentatively recommending 7 systems to monitor the plant, totaling at a value of about \$105,000 for preventative maintenance. The \$20,000 budget was originally given to us as a ballpark price point for our system to be an economic substitution. We will have to confer with Siemens to get their opinion on whether \$105,000 is an economic price on a plant basis.

Our prototype cost is looming around the \$3,000 constraint mark right at \$2,680. This is currently excluding shipping because we were advised to not concern ourselves with the shipping cost by Jonathan Cloos, our financial advisor. This small excess of \$320 will hopefully serve as a buffer for any unaccounted extraneous parts needed next semester.

D. *COMMUNICATIONS*

The internal and external communications for this project have been successful. We have created a combination of means of communication through email, group-me text message, and video conferencing for non-urgent, urgent, and weekly discussions respectively. We also have had successful, frequent communication with our sponsor due to the benefit of our Project Manager being locally located at Siemens Energy. This has been a huge advantage as usually sponsor contact and interest is difficult to maintain. There has also been successful communication about our progress and feedback between our group and the senior design faculty during faculty meetings. It is important that we maintain contact over the month of December with Jonathan Cloos, our financial advisor, to ensure our procurement proceeds smoothly. Also, as a team we will be reconvening January 5th to perform a site visit to communicate with the eventual end customer, Seminole Electric, and tour their plant. We will be using the same communication techniques as a team next semester to continue our success.

VII. CONCLUSION

Each of the components discussed in the previous section are the final selections at this point in time. Though the components selected are considered 'final' for our prototype design, further research will ensue throughout the next phase of the project to continuously improve the conceptual design. Prototyping will also allow our team to further determine and suggest more beneficial component alternatives based on experimental results. Also, prototyping with components that are being used for the proposed design will allow our team to pass along the actual software developed and used to our sponsor, Siemens Energy. This resultant program is deemed most valuable and is our primary focus going forward into the prototyping stage.

REFERENCES

- [1] Team 14, *Solar Wireless Infrared Monitoring System Preliminary Design Proposal*, 2014. http://www.eng.fsu.edu/me/senior_design/2015/team14/TeamFiles/Midterm_I_Report.pdf
- [2] Sharp, James. *Kickoff Meeting Proceedings: Siemens Energy Wireless IR Camera Study*. http://www.eng.fsu.edu/me/senior_design/2015/team14/TeamFiles/KO_Presentation.pdf
- [3] Wikipedia. *Infrared Technology*, 2014. <http://en.wikipedia.org/wiki/Infrared>
- [4] FLIR Instruments. *FLIR Automation Brochure: For Fire Protection and Safety*, 2008 <http://www.flir.com/instruments/display/?id=18092>
- [5] Seminole Electric Cooperative. *R.J. Midulla Generating Station Brochure*. http://www.seminole-electric.com/pdf/SGS_MGS_Brochure.pdf
- [6] DOF Master. *Depth of Field Calculator*, 2005. <http://www.dofmaster.com/dofjs.html>
- [7] FLIR. *Motion Control Systems: Software & Controllers*, 2014. <http://www.flir.com/mcs/view/?id=53771>
- [8] PELCO. *Pelco D Protocol Manual*, 1999. <http://cvs.ru/files/pelco-d.pdf>
- [9] B&B Electronics. *Basics of the RS-485 Standard*. <http://www.bb-elec.com/Learning-Center/All-White-Papers/Serial/Basics-of-the-RS-485-Standard.aspx>
- [10] Versallogic Corporation. *Tiger PC/104-Plus*, 2014. http://www.versallogic.com/new/pr_vl-epm-24.asp
- [11] ICPT, *Link Budget Calculation*. http://www.piscespacific.org/livesite/files/Link_Budget_Calculation.pdf
- [12] NERC. *Summary of Reliability Legislation, 2005*. http://www.nerc.com/AboutNERC/keyplayers/Documents/Summary_of_Reliability_Legislation-20050808.pdf
- [13] PV Depot. *How to Size a Solar Charge Controller*. <http://pvdepot.com/media/size-a-solar-charge-controller.pdf>
- [14] Allen, Gregg. *Solar Pro: Optimal PV to Inverter Sizing Ratio*, 2010. <http://solarprofessional.com/articles/design-installation/optimal-pv-to-inverter-sizing-ratio>
- [15] *SWIMS Project Website*. http://www.eng.fsu.edu/me/senior_design/2015/team14/

APPENDIX 2: HOMER ANALYSIS DATA

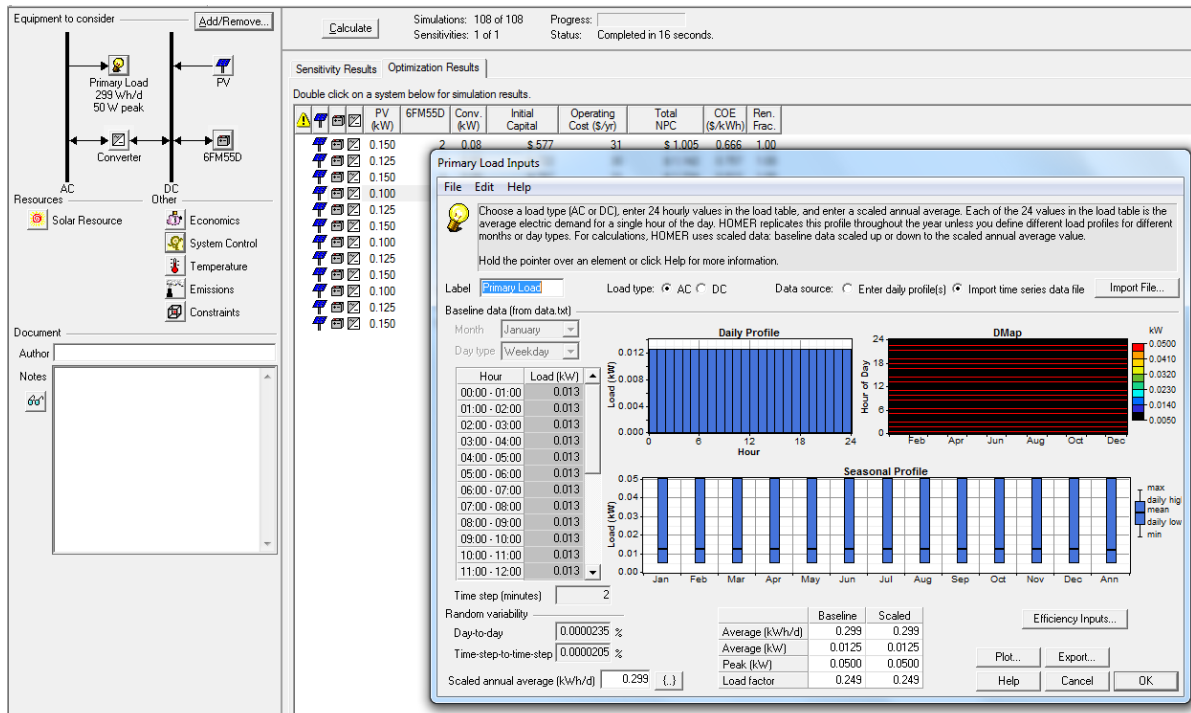

Figure 20. Daily Load Profile Input.

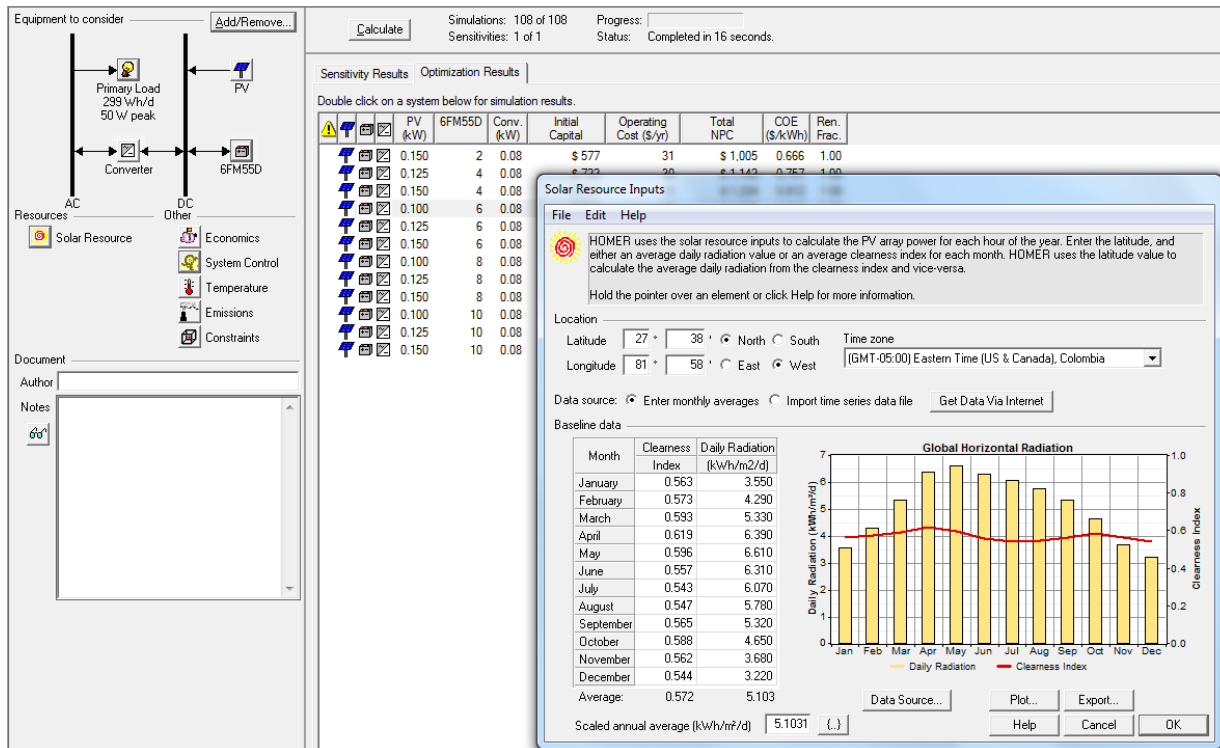

Figure 21. Solar Resource Input.

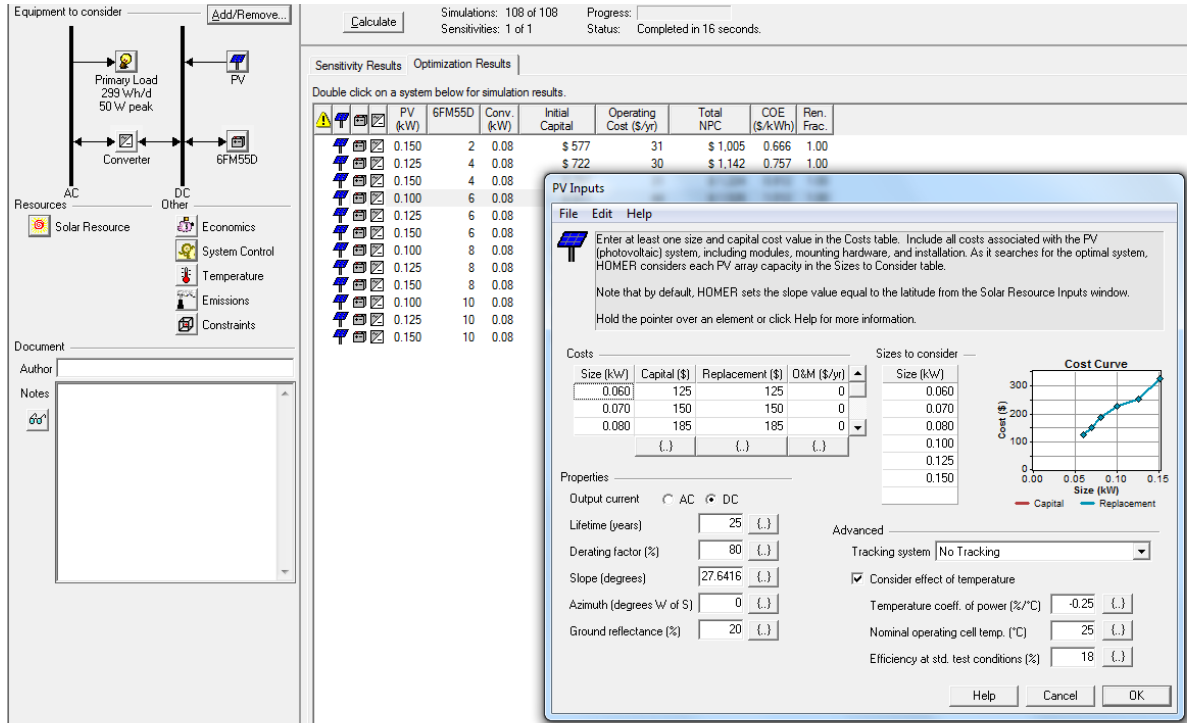

Figure 22. PV Panel Settings.

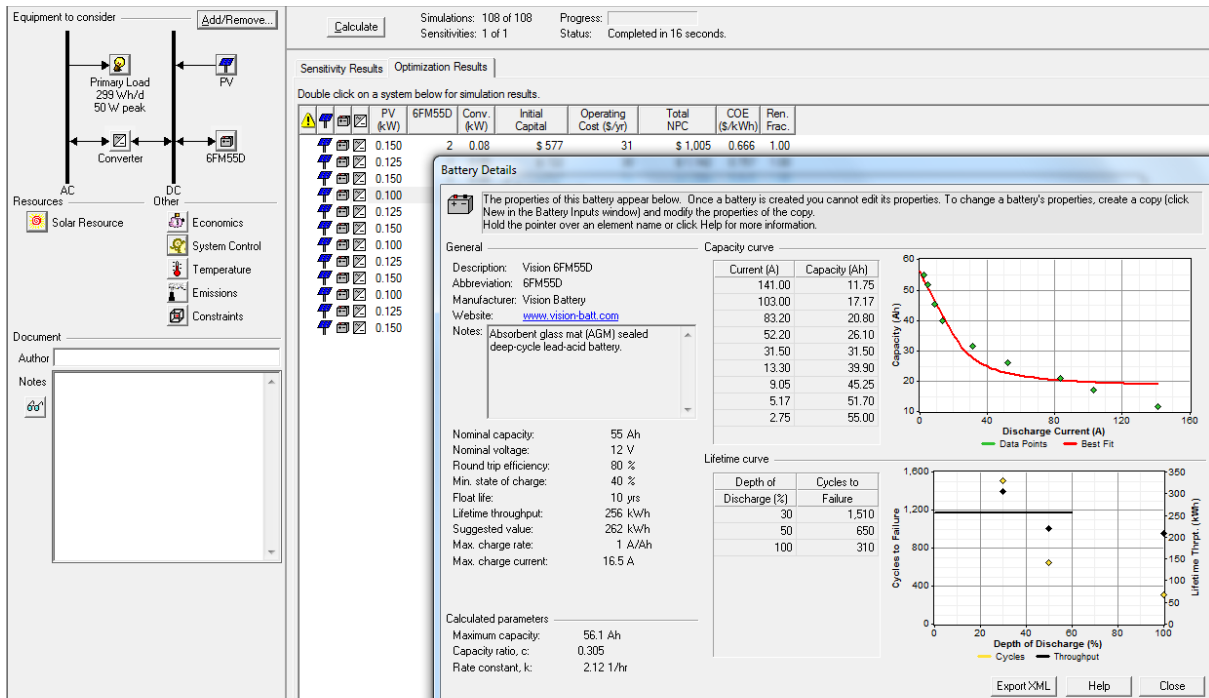

Figure 23. Battery Selection and Settings.

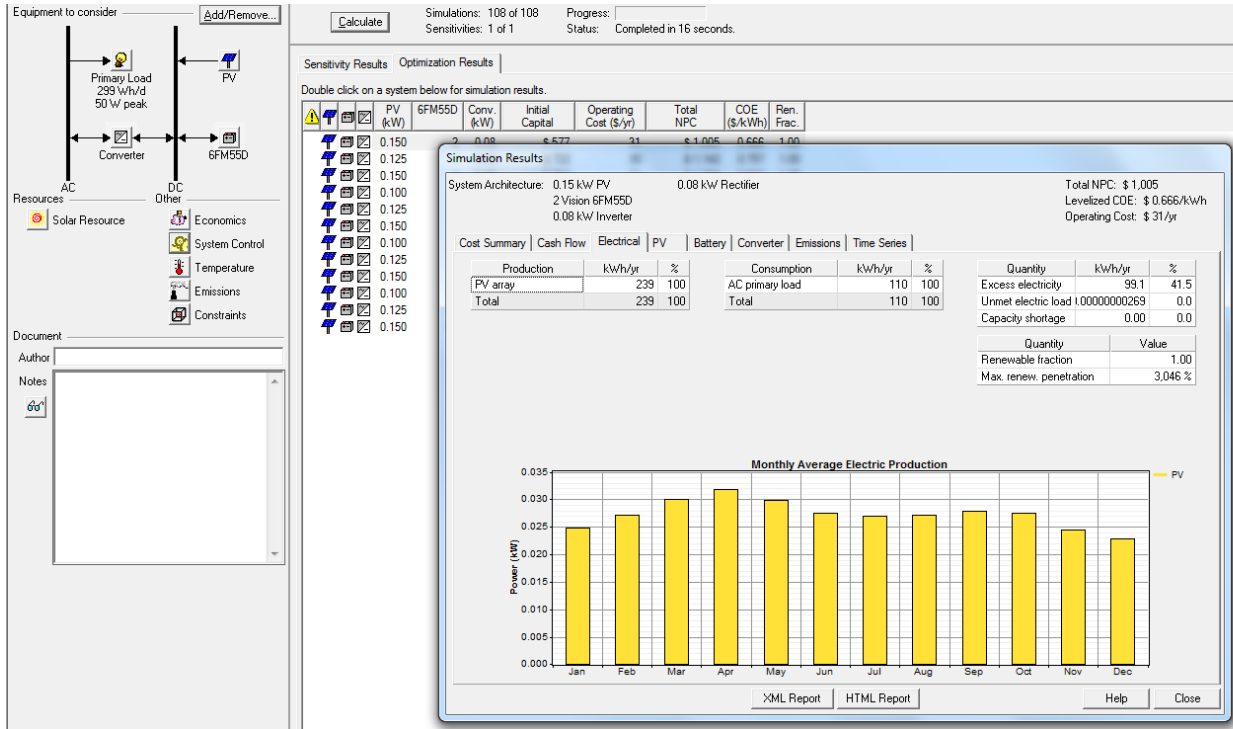

Figure 24. Optimization Results of 150 W Panel with 2 55 Ah Batteries.

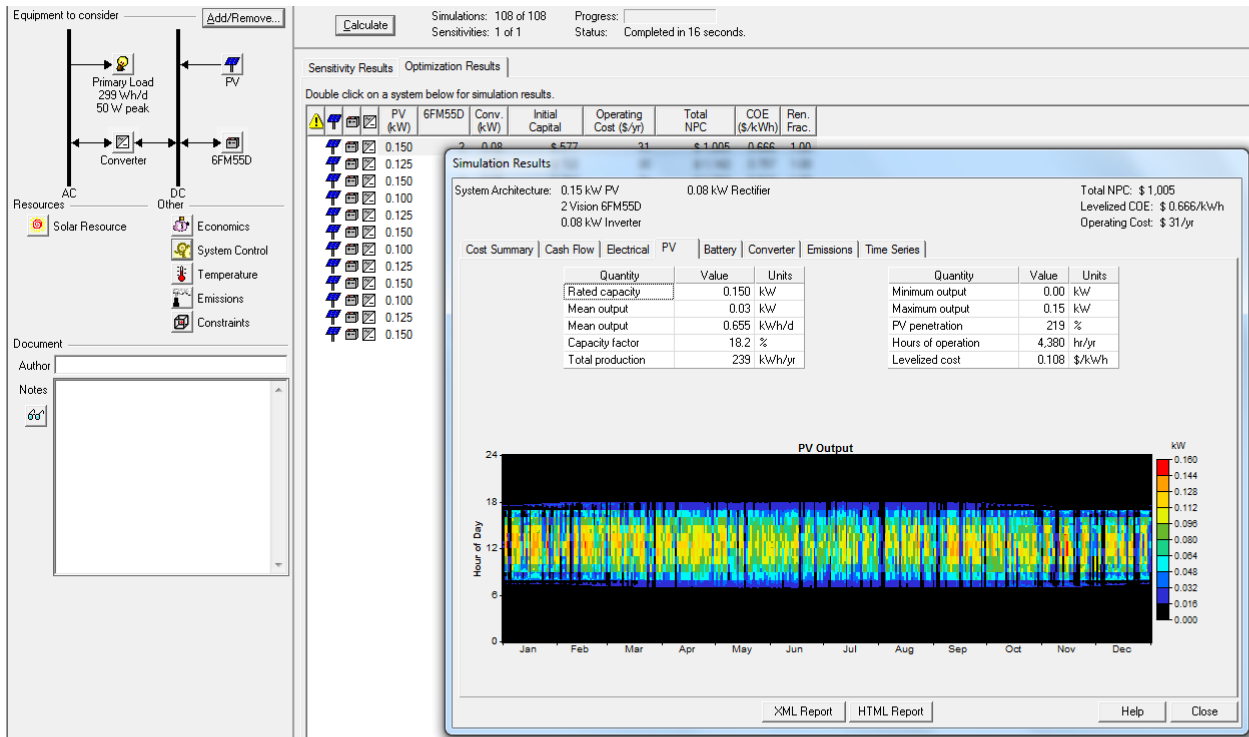

Figure 25. Photovoltaic Analysis.

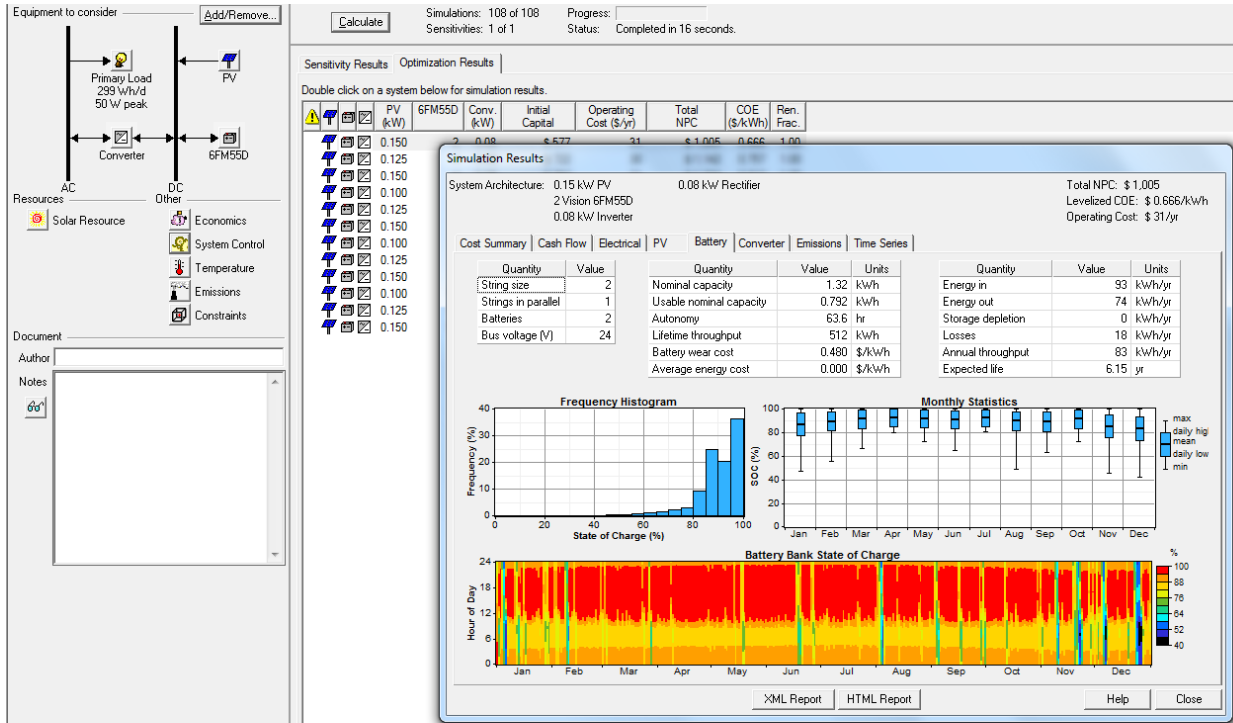

Figure 26. Battery Analysis.

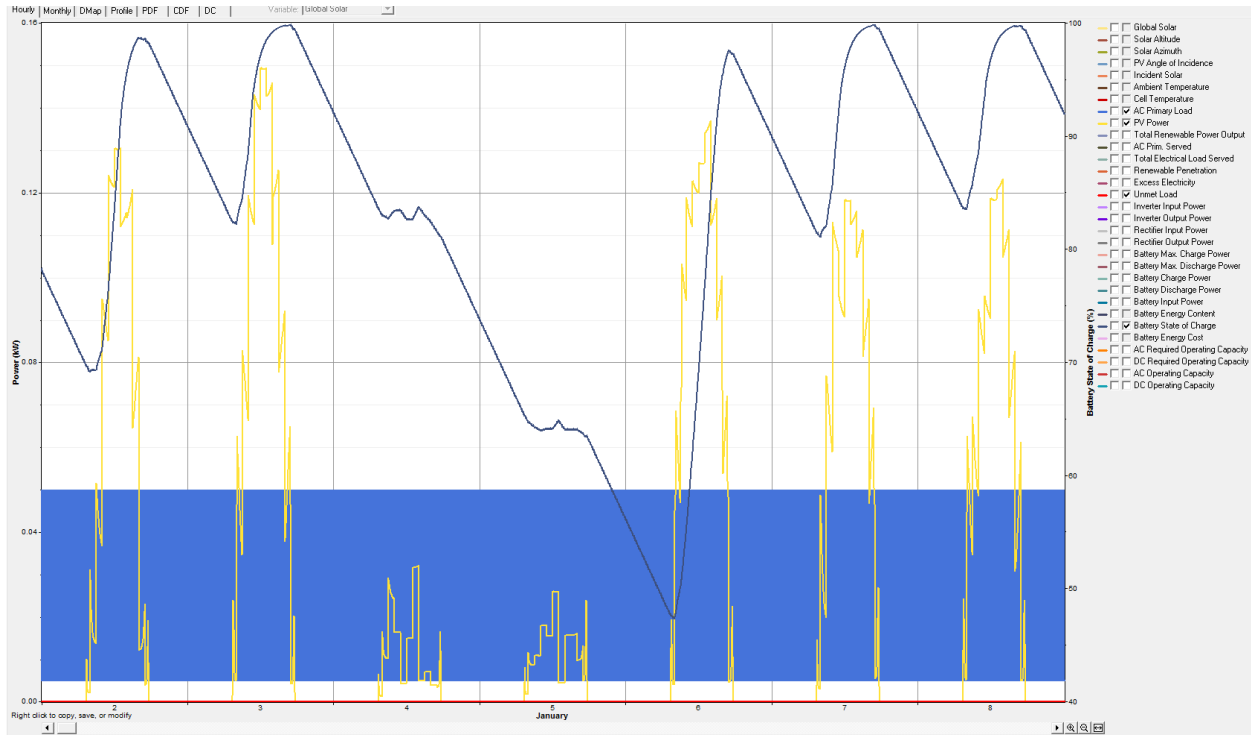

Figure 27. System Charge and Discharge Analysis.

APPENDIX 3: SYSTEM DESIGN SPECIFICATIONS



Technical Data

FLIR A310f 25°

Part number:
61201-1103

Copyright

© 2012, FLIR Systems, Inc.

All rights reserved worldwide. Names and marks appearing herein are either registered trademarks or trademarks of FLIR Systems and/or its subsidiaries. All other trademarks, trade names or company names referenced herein are used for identification only and are the property of their respective owners.

March 08, 2012, 07:56 AM

Corporate Headquarters

FLIR Systems, Inc.
27700 SW Parkway Ave.
Wilsonville, OR 97070
USA
Telephone: +1-503-498-3547

Website

<http://www.flir.com>

Customer support

<http://support.flir.com>

Legal disclaimer

Specifications subject to change without further notice. Camera models and accessories subject to regional market considerations. License procedures may apply.

Information and equipment described herein may require US Government authorization for export purposes. Diversion contrary to US law is prohibited.

**Imaging and optical data**

IR resolution	320 x 240 pixels
Thermal sensitivity/NETD	< 0.05°C @ +30°C (+86°F) / 50 mK
Field of view (FOV) / Minimum focus distance	25° x 18.8° / 0.4 m (1.31 ft.)
Focal length	18 mm (0.7 in.)
Spatial resolution (IFOV)	1.36 mrad
Lens identification	Automatic
F-number	1.3
Image frequency	30 Hz
Focus	Automatic or manual (built in motor)
Zoom	1-8x continuous, digital, interpolating zooming on images

Detector data

Focal Plane Array (FPA) / Spectral range	Uncooled microbolometer / 7.5-13 µm
Detector pitch	25 µm
Detector time constant	Typical 12 ms

Measurement

Object temperature range	-20 to +120°C (-4 to +248°F) 0 to +350°C (+32 to +662°F)
Accuracy	±4°C (±7.2°F) or ±4% of reading

Measurement analysis

Spotmeter	10
Area	10 boxes with max./min./average/position
Isotherm	1 with above/below/interval
Measurement option	Measurement Mask Filter Schedule response: File sending (ftp), email (SMTP)
Difference temperature	Delta temperature between measurement functions or reference temperature
Reference temperature	Manually set or captured from any measurement function
Atmospheric transmission correction	Automatic, based on inputs for distance, atmospheric temperature and relative humidity
Optics transmission correction	Automatic, based on signals from internal sensors
Emissivity correction	Variable from 0.01 to 1.0
Reflected apparent temperature correction	Automatic, based on input of reflected temperature
External optics/windows correction	Automatic, based on input of optics/window transmission and temperature
Measurement corrections	Global and individual object parameters

Alarm

Alarm functions	6 automatic alarms on any selected measurement function, Digital In, Camera temperature, timer
-----------------	--



FLIR A310f 25°

P/N: 61201-1103

© 2012, FLIR Systems, Inc.
All rights reserved worldwide.

Alarm	
Alarm output	Digital Out, log, store image, file sending (ftp), email (SMTP), notification
Set-up	
Color palettes	Color palettes (BW, BW inv, Iron, Rain)
Set-up commands	Date/time, Temperature°C/°F
Storage of images	
Storage media	Built-in memory for image storage
File formats	Standard JPEG, 16-bit measurement data included
Ethernet	
Ethernet	Control, result and image
Ethernet, type	100 Mbps
Ethernet, standard	IEEE 802.3
Ethernet, connector type	RJ-45
Ethernet, communication	TCP/IP socket-based FLIR proprietary
Ethernet, video streaming	MPEG-4, ISO/IEC 14496-1 MPEG-4 ASP@L5
Ethernet, image streaming	16-bit 320 x 240 pixels @ 7-8 Hz - Radiometric
Ethernet, power	Power over Ethernet, PoE IEEE 802.3af class 0
Ethernet, protocols	Ethernet/IP, Modbus TCP, TCP, UDP, SNMP, RTSP, RTP, HTTP, ICMP, IGMP, ftp, SMTP, SMB (CIFS), DHCP, MDNS (Bonjour), uPnP
Digital input/output	
Digital input, purpose	Image tag (start/stop/general), Input ext. device (programmatically read)
Digital input	2 opto-isolated, 10-30 VDC
Digital output, purpose	As function of ALARM, Output to ext. device (programmatically set)
Digital output	2 opto-isolated, 10-30 VDC, max 100 mA
Digital I/O, isolation voltage	500 VRMS
Digital I/O, supply voltage	12/24 VDC, max 200 mA
Digital I/O, connector type	6-pole jackable screw terminal
Composite video	
Video out	Composite video output, PAL and NTSC compatible
Video, standard	CVBS (ITU-R-BT.470 PAL/SMPTE 170M NTSC)
Power system	
External power operation	12/24 VDC, 24 W absolute max
External power, connector type	2-pole jackable screw terminal
Voltage	Allowed range 10-30 VDC
Environmental data	
Operating temperature range	-25°C to +50°C (-13°F to +122°F)
Storage temperature range	-40°C to +70°C (-40°F to +158°F)
Humidity (operating and storage)	IEC 60068-2-30/24 h 95% relative humidity +25°C to +40°C (+77°F to +104°F)
EMC	<ul style="list-style-type: none"> EN 61000-6-2 (Immunity) EN 61000-6-3 (Emission) FCC 47 CFR Part 15 Class B (Emission)
Encapsulation	IP 66 (IEC 60529)
Bump	5 g, 11 ms (IEC 60068-2-27)
Vibration	2 g (IEC 60068-2-6)



FLIR A310f 25°

P/N: 61201-1103
 © 2012, FLIR Systems, Inc.
 All rights reserved worldwide.

Physical data

Weight	5 kg (11.0 lb.)
Size (L x W x H)	460 x 140 x 159 mm (18.1 x 5.5 x 6.3 in.)
Base mounting	TBA
Housing material	Aluminum

System features

External power operation (heater)	24 VDC 25 W max w/heater @ 24 VDC
External power, connector type (heater)	2-pole jackable screw terminal
Voltage (heater)	Allowed range 21-30 VDC
Automatic heaters	Clears window from ice

Scope of delivery

- Cardboard box
- Infrared camera with lens and environmental housing
- Calibration certificate
- Downloads brochure
- FLIR Sensors Manager CD-ROM
- Lens cap
- Printed Getting Started Guide
- Printed Important Information Guide
- Service & training brochure
- Small accessories kit
- User documentation CD-ROM
- FLIR Tools & Utilities CD-ROM
- Registration card

www.axis.com

Technical Specifications - YP3040 Pan-Tilt Motor

Models	YP3040 Pan-Tilt Motor	Power	Consumption: 30 W Input: 24 V AC 50/60 Hz AXIS PS-24 Mains Adaptor recommended (not included)
General		Operating conditions	-20 °C to 65 °C (-4 °F to 149 °F)
Supported cameras	AXIS P13-E, AXIS Q16-E, AXIS Q1755-E and AXIS Q1765-LE PT Mount Network Cameras, AXIS Q1910-E, AXIS Q1922-E, AXIS Q1931-E PT Mount and AXIS Q1932-E PT Mount Thermal Network Cameras, AXIS T92A and AXIS T92E Housings	Approvals	IEC/EN 60529 IP66
Pan/Tilt/Zoom	Pan range 0° to 355° Tilt range 10° to -80° Pan speed 7.5°/s Tilt speed 6°/s Designed for operator control	Dimensions	288 x 165 x 188.5 mm (11 x 6 x 7 in)
Casing	Aluminum alloy Color: White NCS S 1002-B	Weight	4.2 kg (9 lb)
Supported protocols	Pelco-D	Included accessories	Mounting kit, Drill template, Installation guide
Connectors	1x RS485 port	Optional accessories	AXIS T8310 Video Surveillance Control Board, YP3040 Wall Bracket, AXIS T92A20 Housing, AXIS T92E05 Housing, AXIS T92E20 Housing, AXIS PS-24 Mains Adaptor
Mounting	Wall mounting Torque: 1.5 N m (1.1 lb ft) Maximum load: 8 kg (17.6 lb)	Warranty	Axis 1-year warranty, www.axis.com/warranty

More information is available at www.axis.com

57018/EN/MS-2/092014

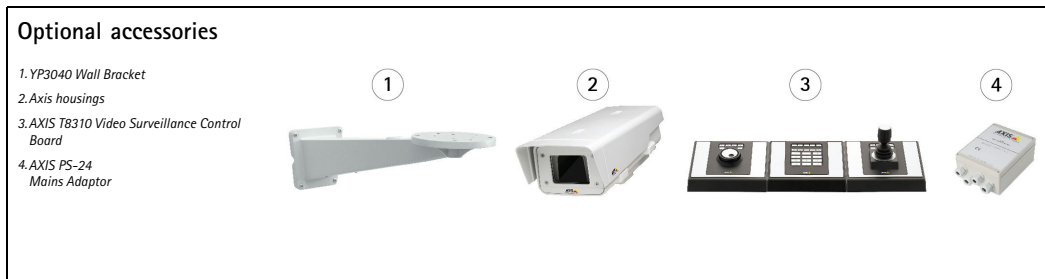
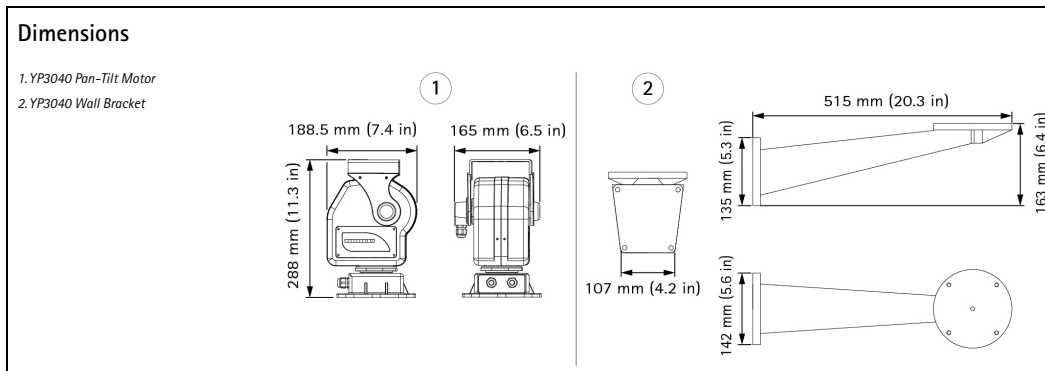

©2014 Axis Communications AB. AXIS COMMUNICATIONS, AXIS, ETRAX, ARTPEC and VAPIX are registered trademarks or trademark applications of Axis AB in various jurisdictions. All other company names and products are trademarks or registered trademarks of their respective companies. We reserve the right to introduce modifications without notice.





is critical in many OEM applications.

The Tiger features an embedded BIOS with OEM enhancements from Phoenix Technologies. The field-reprogrammable BIOS supports custom defaults and the addition of firmware applications for security processes, remote booting, and other pre-OS software functions. The Tiger is compatible with a variety of popular operating systems including Windows, Windows Embedded, Linux, VxWorks, and QNX.

Ordering Information

Model	Processor	Speed	Operating Temp.	Cooling
VL-EPM-24SU	Intel Atom Z530P	1.6 GHz	0° to +60°C	Fanless
VL-EPM-24EU	Intel Atom Z520PT	1.33 GHz	-40° to +85°C	Fanless

Accessories

Part Number	Description
VL-CKR-TIGER	Development cable kit. <i>Includes bold items below.</i>
VL-CBR-1008	ATX power adapter cable
VL-CBR-2012	20" 24-bit LVDS flat panel cable (Hirose)
VL-CBR-2014	LVDS to VGA adapter board
VL-CBR-4405	IDE adapter board
VL-CBR-4406	IDE cable
VL-CBR-5012	I/O cable set and paddleboard
VL-HDW-105	0.6" standoff package (metric thread)
VL-CBR-1401	Cable assembly for (2) SPX modules
VL-CBR-1402	Cable assembly for (4) SPX modules
VL-CBR-1603	Quad USB transition cable
VL-CBR-2010	20" 18-bit LVDS flat panel cable (Hirose)
VL-CBR-2011	20" 18-bit LVDS flat panel cable (JAE)
VL-CDD-xxxx	CD-RW/DVD-ROM drive
VL-ENCL-5D	Development enclosure
VL-F20-xxxx	Disk on Module (IDE)
VL-HDD25-xxx	2.5" hard drive (IDE)
VL-HDW-106	0.6" standoff package (English thread)
VL-HDW-108	DOM hardware kit (metric thread)
VL-HDW-203	PC/104 extractor tool, metal
VL-MM8-xxxx	DDR2 RAM module
VL-PS200-ATX	200W ATX-style development power supply
VL-SPX-x	SPX expansion modules

* Power specifications represent operation at +25°C with +5V supply running Windows XP with 2 GB RAM, Ethernet, keyboard, and mouse. Typical power computed as the mean value of Idle and Maximum power specifications. Maximum power is measured with 95% CPU utilization.

† Signal lines on this port are TVS protected (enhanced ESD protection)

‡ Power pins on this port are overload protected

Specifications are subject to change without notification. Intel and Atom are trademarks of Intel Corp. SpeedStep is a registered trademark of Intel Corp. SPX is a trademark of VersaLogic Corp. All other trademarks are the property of their respective owners.

02/20/13

SPECIFICATIONS

General													
Board Size	PC/104 compliant: 114 mm x 96 mm (4.49" x 3.78")												
Processor + Chipset	<table border="1"> <thead> <tr> <th>Model</th> <th>Processor</th> <th>Speed</th> <th>Chipset</th> </tr> </thead> <tbody> <tr> <td>VL-EPM-24SU</td> <td>Atom Z530P</td> <td>1.6 GHz</td> <td>US15WP</td> </tr> <tr> <td>VL-EPM-24EU</td> <td>Atom Z520PT</td> <td>1.33 GHz</td> <td>US15WPT</td> </tr> </tbody> </table> <p>533 MHz FSB. Dynamic 512 KB L2 cache. Supports Enhanced Intel SpeedStep Technology and Hyper-Threading Technology (HTT).</p>	Model	Processor	Speed	Chipset	VL-EPM-24SU	Atom Z530P	1.6 GHz	US15WP	VL-EPM-24EU	Atom Z520PT	1.33 GHz	US15WPT
Model	Processor	Speed	Chipset										
VL-EPM-24SU	Atom Z530P	1.6 GHz	US15WP										
VL-EPM-24EU	Atom Z520PT	1.33 GHz	US15WPT										
Power Requirements *	<table border="1"> <thead> <tr> <th>Model</th> <th>Sleep (S3)</th> <th>Typical</th> </tr> </thead> <tbody> <tr> <td>VL-EPM-24SU</td> <td>0.21A (1.05W)</td> <td>1.20A (6.0W)</td> </tr> <tr> <td>VL-EPM-24EU</td> <td>0.23A (1.15W)</td> <td>1.18A (5.9W)</td> </tr> </tbody> </table>	Model	Sleep (S3)	Typical	VL-EPM-24SU	0.21A (1.05W)	1.20A (6.0W)	VL-EPM-24EU	0.23A (1.15W)	1.18A (5.9W)			
Model	Sleep (S3)	Typical											
VL-EPM-24SU	0.21A (1.05W)	1.20A (6.0W)											
VL-EPM-24EU	0.23A (1.15W)	1.18A (5.9W)											
Hardware Monitors	<table border="1"> <thead> <tr> <th>Watchdog Timer</th> <th>Power Quality Monitor</th> </tr> </thead> <tbody> <tr> <td>1 second to 255 minutes. Warm reset, cold reset, or power down.</td> <td>System reset on undervoltage conditions</td> </tr> </tbody> </table>	Watchdog Timer	Power Quality Monitor	1 second to 255 minutes. Warm reset, cold reset, or power down.	System reset on undervoltage conditions								
Watchdog Timer	Power Quality Monitor												
1 second to 255 minutes. Warm reset, cold reset, or power down.	System reset on undervoltage conditions												
Stackable Bus	PC/104-Plus (PCI, ISA)												
Other I/O Expansion	VersaLogic SPX interface												
RoHS	Compliant												
Environmental													
Operating Temperature	<table border="1"> <thead> <tr> <th>Model</th> <th>Operating Temperature</th> </tr> </thead> <tbody> <tr> <td>VL-EPM-24SU</td> <td>0° to +60°C</td> </tr> <tr> <td>VL-EPM-24EU</td> <td>-40° to +85°C</td> </tr> </tbody> </table>	Model	Operating Temperature	VL-EPM-24SU	0° to +60°C	VL-EPM-24EU	-40° to +85°C						
Model	Operating Temperature												
VL-EPM-24SU	0° to +60°C												
VL-EPM-24EU	-40° to +85°C												
Storage Temperature	-40° to +85°C												
Airflow Requirements	<table border="1"> <thead> <tr> <th>Model</th> <th>Airflow Requirements</th> </tr> </thead> <tbody> <tr> <td>VL-EPM-24SU</td> <td>Free air from 0° to +60°C</td> </tr> <tr> <td>VL-EPM-24EU</td> <td>100 LFM from +60° to +85°C</td> </tr> </tbody> </table>	Model	Airflow Requirements	VL-EPM-24SU	Free air from 0° to +60°C	VL-EPM-24EU	100 LFM from +60° to +85°C						
Model	Airflow Requirements												
VL-EPM-24SU	Free air from 0° to +60°C												
VL-EPM-24EU	100 LFM from +60° to +85°C												
Thermal Shock	5°C/min. over operating temperature												
Humidity	Less than 95%, noncondensing												
Vibration, Sinusoidal Sweep	MIL-STD-202G, Method 204, Modified Condition A: 2g constant acceleration from 5 to 500 Hz, 20 minutes per axis												
Vibration, Random	MIL-STD-202G, Method 214A, Condition A: 5.35g rms, 5 minutes per axis												
Mechanical Shock	MIL-STD-202G, Method 213B, Condition G: 20g half-sine, 11 ms duration per axis												
Memory													
System RAM	SO-DIMM socket. Up to 2 GB DDR2 SDRAM.												
Video													
General	Integrated high-performance video. Intel GMA 500 graphics core supports advanced 3D graphics and high-definition video decode.												
VRAM	Up to 256 MB shared DRAM												
OEM Flat Panel Interface	18/24-bit LVDS interface. CMOS-selectable TFT panel types. Up to 1280 x 1024 (24 bits) @ 85 Hz.												
Desktop Display Interface	Analog output (VGA) via optional adapter cable †												
Mass Storage													
Hard Drive	IDE controller (ATA-6, UDMA/100) supports two IDE devices												
Flash	Right angle IDE Disk on Module (DOM) site with retention screw												
Network Interface													
Ethernet †	Autodetect 10BaseT/100BaseTX/1000BaseT port												
Network Boot Option	Intel boot agent (downloadable) supports PXE protocol. Argon Managed Boot Agent (optional with royalty fee) supports PXE, RPL, NetWare, TCP/IP (DHCP, BOOTP) remote boot protocols.												
Device I/O													
USB ††	Seven USB 2.0/1.1 ports (one client, six host)												
COM 1/2/3/4 †	RS-232/422/485 selectable. 16C550 compatible. 460 Kbps.												
Audio	Intel High Definition Audio (HDA) compatible. Stereo line in/out.												
Software													
BIOS	Phoenix Technologies Embedded BIOS with OEM enhancements. Field reprogrammable. Support for USB boot. User-configurable CMOS defaults.												
Sleep Mode	ACPI 2.0 compatible												
Operating Systems	Compatible with most x86 operating systems including Windows, Windows Embedded, Linux, VxWorks, and QNX												



www.edimax.com

150Mbps Wireless IEEE802.11b/g/n nano USB Adapter

EW-7811Un

FEATURES AND TECHNICAL SPECIFICATIONS

- ✿ Complies with wireless 802.11b/g/n standards with data rate up to 150Mbps
- ✿ Green Power Saving : supports smart transmit power control and auto-idle state adjustment
- ✿ Increases wireless coverage 3 times* further
- ✿ Includes multi-language easy setup wizard
- ✿ Supports 64/128-bit WEP, WPA , WPA2 encryption and WPS-compatible
- ✿ Supports QoS-WMM, WMM-Power Save mode

TECHNICAL SPECIFICATIONS

HARDWARE INTERFACE	STANDARD	FREQUENCY BAND
<ul style="list-style-type: none"> ✿ 1 USB 1.0/2.0 Type A ✿ Internal Antenna 	<ul style="list-style-type: none"> ✿ IEEE802.11b, 802.11g, 802.11n 	<ul style="list-style-type: none"> ✿ 2.4000~2.4835GHz (Industrial Scientific Medical Band)
DATA RATE	INSTALLATION	LED & DIMENSION
<ul style="list-style-type: none"> ✿ 11b: 1/2/5.5/11Mbps ✿ 11g: 6/9/12/24/36/48/54Mbps ✿ 11n (20MHz): MCS0-7 (up to 72Mbps) ✿ 11n (40MHz): MCS0-7 (up to 150Mbps) 	<ul style="list-style-type: none"> ✿ Multi-language easy setup wizard with auto run configuration 	<ul style="list-style-type: none"> ✿ Link/Activity ✿ 7.1(H) x 14.9 (W) x 18.5 (D) mm
SECURITY	OUTPUT POWER	HUMIDITY & TEMPERATURE
<ul style="list-style-type: none"> ✿ WEP 64/128, WPA, WPA2, and IEEE802.1x ✿ Software WPS configuration 	<ul style="list-style-type: none"> ✿ 11b:17 ±1.5dbm ✿ 11g:b:15 ±1.5dbm ✿ 11n:14 ±1.5dbm 	<ul style="list-style-type: none"> ✿ Operating : 10~90% (Non Condensing) Storage : Max. 95% (Non Condensing) ✿ Operating : 32~104°F (0~40°C) Storage : -4~140°F (-20~60°C)
SYSTEM REQUIREMENTS	RECEIVE SENSITIVITY	CERTIFICATIONS
<ul style="list-style-type: none"> ✿ Windows XP/Vista/7/8/8.1 ✿ Linux & Mac OS 	<ul style="list-style-type: none"> ✿ 11n(20MHz)@MCS7: -68dBm±2dBm 11n(40MHz)@MCS7: -64dBm±2dBm ✿ 11g@54Mbps: -71dBm±2dBm ✿ 11b@11Mbps: -81dBm±2dBm 	<ul style="list-style-type: none"> ✿ CE, FCC , WiFi

APPLICATION DIAGRAM

An example of how the EW-7811Un can be setup:

- Connects the EW-7811Un wireless adapter to your computer.
- Sets up the wireless connection by running the multi-language easy setup wizard.
- Connects to 802.11b/g/n wireless access point or broadband router.



Maximum performance, actual data rates, and coverage will vary depending on network conditions and environmental factors. Product specifications and design are subject to change without notice. Copyright © 2014 Edimax Technology Co. Ltd. All rights reserved. www.edimax.com



2.4GHz 15dBi Outdoor Omni-directional Antenna TL-ANT2415D

◎ Specifications:

Frequency	2.4 ~ 2.5 GHz
S.W.R.	<= 2.0
Antenna Gain	15 dBi
Polarization	Linear
Impedance	50 Ohms
HBBW @ H-Plane	360 Degree Omni-Directional
HPBW @ E-Plane	<= 9 Degree
Handle Power	20 Watt
Material of Radiator	Cu & Zn-Alloy
Material of Plastic Body	Glass Fiber
Cable Type	RG 316D
Connector Type	N Jack
Connector Pull Test	>= 8 Kg
Operation Temperature	- 40 °C ~ + 65 °C
Standards	RoHS, WEEE

◎ Diagram:



Package:

- 15dBi Outdoor Omni-directional Antenna
- Installation mounting kits
- User Guide

Related Products:

- 54Mbps High Power Wireless Access Point TL-WA5110G
- 150Mbps Wireless N Access Point TL-WA701ND

AC1750 Dual Band Wireless Router

TEW-812DRU [v1.0R]



SPECIFICATIONS

HARDWARE

Standards	<ul style="list-style-type: none"> Wired: IEEE 802.3 (10Base-T), IEEE 802.3u (100Base-TX), IEEE 802.3ab (1000Base-T) Wireless: IEEE 802.11ac (draft), IEEE 802.11n, IEEE 802.11g, IEEE 802.11b, 802.11a
Internet Protocol	<ul style="list-style-type: none"> IPv4 and IPv6
LAN	<ul style="list-style-type: none"> 4 x 10/100/1000 Mbps Auto-MDIX
WAN	<ul style="list-style-type: none"> 1 x 10/100/1000 Mbps Auto-MDIX
USB	<ul style="list-style-type: none"> 1 x USB 2.0 Type-A (Storage / Printing)
WPS Button	<ul style="list-style-type: none"> Wi-Fi Protected Setup (WPS) connects with other WPS compliant devices
Reset Button	<ul style="list-style-type: none"> Reset unit back to factory default (press and hold for 10 seconds)
Network Protocols / Features	<ul style="list-style-type: none"> IGMP v1/2/3 proxy and snooping, Static and dynamic routing, UPnP, DHCP, server, Dynamic DNS (No-IP.com and DynDNS.com), NTP, IPsec / PPTP / L2TP VPN pass through, IPv6
Quality of Service	<ul style="list-style-type: none"> WMM and WAN (Configurable Upload / Download)
Control Center Utility OS Support	<ul style="list-style-type: none"> Windows® 8.1, 8, 7, Vista, XP Mac OS® 10.4-10.9
Internet Connection Type	<ul style="list-style-type: none"> IPv6, Dynamic IP, Static (fixed) IP, PPPoE, PPTP, L2TP
Firewall	<ul style="list-style-type: none"> NAT, SPI, DMZ host, virtual servers, MAC / IP filters and URL filter
Management / Monitoring	<ul style="list-style-type: none"> Local / remote configuration, upgrade firmware, backup / restore configuration via web browser, internal system log, ping test tool
Supported Web Browser	<ul style="list-style-type: none"> Internet Explorer 6.0 or above, Firefox 2.0 or above, Chrome, Opera, Safari
LED Indicator	<ul style="list-style-type: none"> Power, LAN 1-4, WAN, 2.4 GHz Wireless, 5 GHz Wireless, WPS
Power Adapter	<ul style="list-style-type: none"> Input: 100 ~ 240 V, 50~60 Hz, 0.8 A Output: 12 V DC, 2 A external power adapter
Power Consumption	<ul style="list-style-type: none"> 18 watts (max.)
Dimension (L x W x H)	<ul style="list-style-type: none"> 48 x 155 x 180 mm (1.9 x 6.1 x 7.1 in)
Weight	<ul style="list-style-type: none"> 395 g (14 oz)
Temperature	<ul style="list-style-type: none"> Operation: 0°~ 40°C (32°F~ 104°F) Storage: -20°~ 60°C (-4°F~140°F)
Humidity	<ul style="list-style-type: none"> Max 90% (non-condensing)
Certifications	<ul style="list-style-type: none"> CE, FCC

TEW-812DRU
rev: 12.05.2012

140W AND 150W PHOTOVOLTAIC MODULES - 140J AND 150J

Electrical characteristics

140J / 150J

	⁽¹⁾ STC 1000W/m ²	⁽²⁾ NOCT 800W/m ²
Maximum power (P _{max})	140W / 150W	101W / 108W
Voltage at P _{max} (V _{mp})	17.5V / 18.1V	15.6V / 16.2V
Current at P _{max} (I _{mp})	8.0A / 8.3A	6.5A / 6.7A
Short circuit current (I _{sc})	8.2A / 8.5A	6.6A / 6.9A
Open circuit voltage (V _{oc})	22.0V / 22.2V	20.0V / 20.2V
Module efficiency	13.7% / 14.6%	
Tolerance (P _{max})		+10% / -5%
Nominal voltage		12V
Efficiency reduction at 200W/m ²	<5% reduction efficiency 13.0% / 13.8%	
Limiting reverse current	8.2A / 8.5A	
Temperature coefficient of I _{sc}	0.105%/°C	
Temperature coefficient of V _{oc}	-0.360%/°C	
Temperature coefficient of (P _{max})	-0.45%/°C	
⁽³⁾ NOCT	47±2°C	
Maximum series fuse rating	20A	
Application class (according to IEC 61730:2007)	Class C	

Maximum system voltage 600V (U.S. NEC) / 1000V (IEC 61730:2007)
 1: Values at Standard Test Conditions (STC): 1000W/m² irradiance, AM1.5 solar spectrum and 25°C module temperature
 2: Values at 800W/m² irradiance, Nominal Operation Cell Temperature (NOCT) and AM1.5 solar spectrum
 3: Nominal Operation Cell Temperature: Module operation temperature at 800W/m² irradiance, 20°C air temperature, 1m/s wind speed

Mechanical characteristics

Solar cells	36 crystalline 6" silicon cells (156 x 156mm) in series
Front cover	High transmission 3.2mm (1/8th in) glass
Encapsulant	EVA
Back cover	White polyester
Frame	Silver anodized aluminum
Junction box	IP65 with 4 terminal screw connection block; accepts PG 13.5, M20 13mm (1/2") conduit, or cable fittings accepting 6-12mm diameter cable. Terminals accept 2.5-10mm ² (8-14 AWG) wire
Dimensions	1510 x 674 x 50mm / 59.4 x 26.5 x 2in
Weight	12kg / 26.5lbs

All dimensional tolerances within ±1% unless otherwise stated.

Warranty*

- ▶ Free from defects in materials and workmanship for 2 years
- ▶ 90% min. power output over 12 years
- ▶ Optional 25 years available

* Refer to warranty document for terms and conditions.

Certification

Certified according to the extended version of the IEC 61215 (ed.2), EN 61215:2005-08 (Crystalline silicon terrestrial photovoltaic modules - Design qualification and type approval).

Certified according to IEC 61730-1 and IEC 61730-2 (ed.1), EN 61730-1:2007-05 and EN 61730-2:2007-05. (Photovoltaic module safety qualification, requirements for construction and testing).

Listed to UL 1703 & ULC ORD-C1703 Standard for Safety by Intertek ETL. Class C Fire Rating.

Approved by Intertek ETL according to FM 3611, Dec 2004, and according to CAN/CSA C22.2 No. 213-M1987, 1st Edition, Reaffirmed 2004, for use in a Class I, Division 2, Group A, B, C, D Hazardous (Classified) Location.

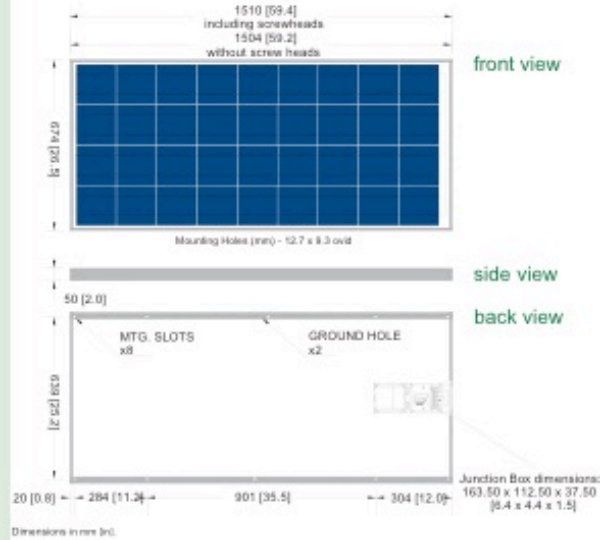

Temperature - dependence of performance (140 module)

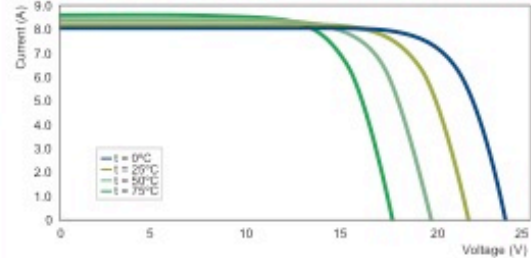

Irradiance - dependence of performance (140 module)

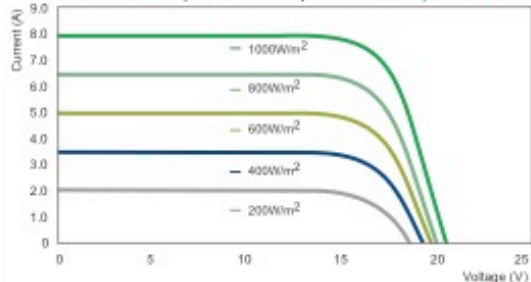

For more information, call 855-43-SOLAR or visit www.amerescosolar.com.

This publication summarizes product warranty and specifications which are subject to change without notice. © 2013 Ameresco, Inc. Ameresco and the Ameresco logo, the oct symbol and the tagline "Green, Clean, Sustainable" are registered in the U.S. Patent and Trademark Office. All rights reserved. PG-5163-01-1113 10/00.0



Sealed Lead-Acid Battery

Absorbant Glass Mat (AGM) technology for superior performance. Valve regulated, spill proof construction allows safe operation in any position. Approved for transport by air. D.O.T., I.A.T.A., F.A.A. and C.A.B. certified. U.L. recognized under file number MH 20567.

UPG No. 45978

UB121000

Maintenance-Free

Specification

Nominal Voltage	12 volts		
Nominal Capacity	77° F (25° C)		
20-hr. (5.0A)	100 Ah		
10-hr. (9.3A)	93 Ah		
5-hr. (17.0A)	85Ah		
1-hr. (60.0A)	60 Ah		
Approximate Weight	59.2 lbs (26.9 kgs)		
Internal Resistance (approx.)	5mΩ		
Shelf Life (% of normal capacity at 77° F (25° C))			
3 Months	6 Months	12 Months	
91%	82%	64%	
Temperature Dependency of Capacity	(20 hour rate)		
104° F	77° F	32° F	5° F
102%	100%	85%	65%



Charge Method (Constant Voltage)

Cycle Use (Repeating Use)

Initial Current	35 A or smaller
Control Voltage	14.5 - 14.9 V

Float Use

Control Voltage	13.6 - 13.8 V
-----------------	---------------

Physical Dimensions: in (mm)

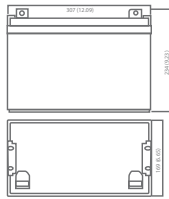

L: 12.09in (307 mm)
W: 6.65in (169 mm)
H: 8.58in (140 mm)
TH: 9.23in (234 mm)
 Tolerances are +/- 0.04 in. (+/- 1mm) and +/- 0.08 in. (+/- 2mm) for height dimensions. All data subject to change without notice.

Terminals

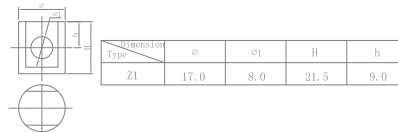

Constant Current Discharge Characteristics Unit:A (25°C, 77°F)

F.V/Time	5MIN	10MIN	15MIN	30MIN	1HR	2HR	3HR	4HR	5HR	8HR	10HR	20HR
9.60V	351.5	256.5	180.5	109.3	57.0	33.3	24.4	19.0	15.7	11.0	10.0	5.4
10.20V	309.7	233.7	161.5	103.6	53.6	31.7	23.8	18.5	15.4	10.8	9.7	5.3
10.50V	298.3	222.3	152.0	100.7	52.3	31.0	23.2	18.2	15.2	10.7	9.5	5.2
10.80V	286.9	210.9	142.5	97.9	50.4	30.2	22.6	18.0	14.8	10.5	9.5	5.1
11.10V	275.5	199.5	133.0	95.0	48.5	29.5	21.9	17.4	14.4	10.2	9.0	4.9

Constant Power Discharge Characteristics Unit:W (25°C, 77°F)

F.V/Time	5MIN	10MIN	15MIN	30MIN	1HR	2HR	3HR	4HR	5HR	8HR	10HR	20HR
9.60V	3732.6	2818.7	1917.1	1160.0	660.3	384.8	283.1	220.4	181.5	128.3	115.9	62.4
10.20V	3438.1	2594.5	1792.7	1149.5	620.4	367.7	275.5	214.7	142.6	125.4	113.1	60.8
10.50V	3383.0	2521.3	1723.3	1141.9	600.4	359.1	268.9	210.9	175.8	124.5	111.2	60.0
10.80V	3339.3	2454.8	1658.7	1139.1	584.3	351.5	263.2	207.1	172.9	121.6	110.2	59.8
11.10V	3278.5	2374.1	1582.7	1130.5	576.7	350.6	260.3	206.2	172.0	120.7	107.4	58.0

www.upgi.com



VR081010

1720 Hayden Drive | Carrollton, Texas 75006 | P 469.892.1122 | T 866.892.1122 | F 469.892.1123 | sales@upgi.com

UB121000

Maintenance-Free

Discharge Time vs. Discharge Current

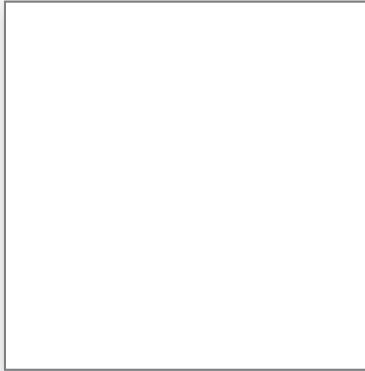

Discharge Characteristics

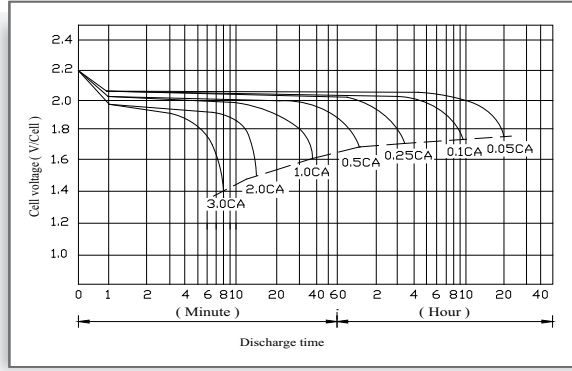

Shelf Life & Storage

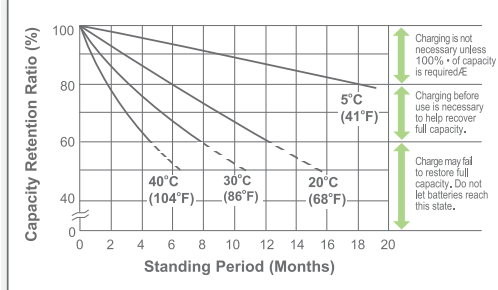

Cycle Life vs Depth of Discharge

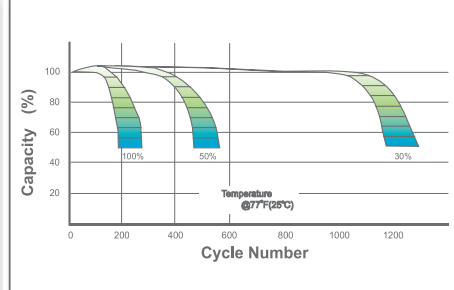

Open Circuit Voltage vs Residual Capacity

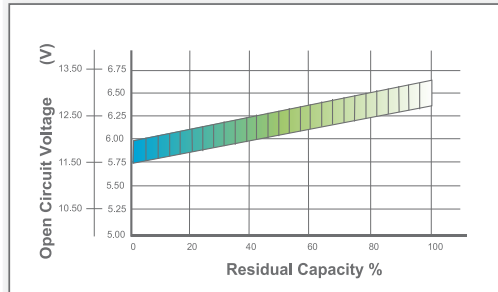

Effect of Temperature on Capacity

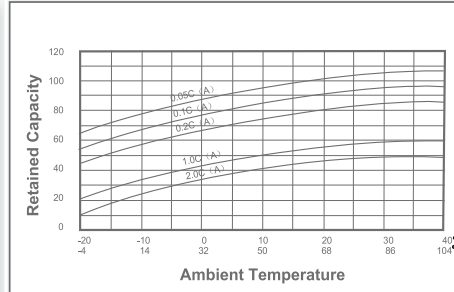

Charge Current & Final Discharge Voltage

Application	Charge Voltage(V/Cell)			Max.Charge Current	Final Discharge Voltage V/Cell	1.75	1.70	1.60	1.30
	Temperature	Set Point	Allowable Range						
Cycle Use	25°C (77°F)	2.45	2.40-2.50	0.35C	Discharge Voltage V/Cell	1.75	1.70	1.60	1.30
Standby	25°C (77°F)	2.325	2.30-2.35		Discharge Current(A)	0.2C<(A)	0.2C<(A)<0.5C	0.5C<(A)<1.0C	(A)>1.0C



Let UPG Power Your Life.

www.upgi.com

1720 Hayden Drive | Carrollton, Texas 75006 | P 469.892.1122 | T 866.892.1122 | F 469.892.1123 | sales@upgi.com

Home » Inverter & Charge controller » Solar charge controller » 20A MPPT Solar Charge Controller Free shipping



20A MPPT Solar Charge Controller Free Shipping

Model: MPPT20-1

Rating: ★★★★★

Price: \$102.00

Shipping : Estimated in Cart

Quantity:

[Add to Cart](#) -OR- [Add to Wish List](#)



Free Shipping to World- Wide !

20A MPPT (Max Power Point Tracking) solar charge controller, solar regulator the efficiency increased by 15-30%

Package included

- 1PCS 20A MPPT charge controller
- 1PCS english version manual

Features

1. Increases charge efficiency by 20% - 43%
2. High technology MPPT with LCD display, efficiency > 98%
3. Employs a DC converting circuit、 conversion efficiency > 96%
4. MPPT demo displays the efficiency of this controller compared to PCM models
5. Functions as a power meter
6. LCD display shows the battery voltage, charging current, charging power, output status,
7. output mode, time and accumulated power saving
8. Suitable for a wide range of batteries
9. Maximum charge and discharge current 20A
10. Five output modes: Manual、 Standard、 Timer、 Light sensor、 Light sensor on + Timer off.
11. Built in timer, suitable for a periodic discharge system such as solar street lights, solar pumps etc.
12. Over charge, over discharge, overload and short circuit protection
13. 3-stage charging algorithm, impulse, bulk and float
14. Fully Aluminium housing incorporating a large heat sink
15. Low stand-by power consumption

Specification

Rated system voltage	12V/24V DC
Max open circuit voltage of solar panel	15-42V DC
Max solar panel power	300w 12V
Max output current	20A
Max discharge current	20A
Over discharge voltage	10.2-12.5V(+/- 0.2)
Restart voltage	10.2-13.5V(+/- 0.2)
Constant voltage (Over charge)voltage	13-15.5V(+/- 0.2)
Float voltage	12.5-14.5V(+/- 0.2)
Converter type	Buck
Converter efficiency	>96%
Max increase efficiency	>43%
Tracking efficiency	>98%
Precision of clock	+/- 50S/Month
Charging algorithm	PWM 3 stage
Stand by power consumption	<15mA 12V / <25mA 24V
Operating temperature	-20 to +50 degree C
protect class	IP22
Size	140mm*147mm*42mm
weight	550g



samlexamerica **150W**

DC-AC Inverter
Pure Sine Wave

Model
 PST-15S-12A
 12 VDC-120 VAC
 PST-15S-24A
 24 VDC-120 VAC

Design Features

- High efficiency
- Low battery voltage alarm
- LED indicators for power and protections
- Protections: input low voltage, input over voltage, over temperature, over load, short circuit
- Low idle power draw
- Comes with cigar lighter plug

2 YEAR WARRANTY

	MODEL NO.	PST-15S-12A	PST-15S-24A
OUTPUT	POWER, CONTINUOUS	150 Watts	150 Watts
	POWER, SURGE (FOR <1 SEC)	300 Watts	300 Watts
	OUTPUT VOLTAGE	120 V AC +/- 3%	120 V AC +/- 3%
	OUTPUT FREQUENCY	60 Hz	60 Hz
	OUTPUT VOLTAGE WAVEFORM	Pure Sine Wave	Pure Sine Wave
	TOTAL HARMONIC DISTORTION	< 3%	< 3%
INPUT	INPUT VOLTAGE	10.5 to 16.5 VDC	21 to 33 V DC
	INPUT CURRENT AT NO LOAD	< 600 mA	< 400 mA
	LOW INPUT VOLTAGE WARNING ALARM	10.5 V	21 V
	LOW INPUT VOLTAGE SHUT-DOWN	10 V	20 V
	HIGH INPUT VOLTAGE SHUT-DOWN	16.5 V	33 V
	OPERATING AMBIENT TEMPERATURE	0 to 40°C +/- 5°C	0 to 40°C +/- 5°C
	PEAK EFFICIENCY	85%	85%
	COOLING	Temperature Controlled Fan	
CONNECTIONS	INPUT	Cigarette Lighter Plug	
	OUTPUT	1 Standard North American Outlet (NEMA 5-15R)	
	DC SIDE INPUT FUSE	20 A	10 A
GENERAL	DIMENSIONS, MM (L x W x H)	215 x 147 x 66 mm	215 x 147 x 66 mm
	DIMENSIONS, INCHES (L x W x H)	8.5 x 5.8 x 2.6"	8.5 x 5.8 x 2.6"
	WEIGHT, KG	1.3	1.3
	WEIGHT, LB	2.9	2.9

NOTE: Specifications are subject to change without notice

To view a full selection of Samlex products visit our website at www.samlexamerica.com or contact us: 1(800) 561-5885 or sales@samlexamerica.com

**TRACO
POWER****DC/DC Converters**
TSR-1 Series **1 A****Input Specifications**

Maximum input current (at V_{in} min. and 1 A output current)	1 A
No load input current	1 mA typ.
Reflected ripple current	150 mA
Input filter	internal capacitors, see application notes for to meet EN55022 class A

Output Specifications

Voltage set accuracy	$\pm 2\%$ (at full load)
Regulation	<ul style="list-style-type: none"> - Input variation - Load variation (10 – 100 %) 1.2 & 1.5 VDC models: <li style="padding-left: 20px;">other models:
Overshoot startup voltage	1.0 % max.
Minimum load	not required
Ripple and noise (20 MHz Bandwidth)	<ul style="list-style-type: none"> 1.2 – 6.5 VDC models: 9 – 15 VDC models:
Temperature coefficient	$\pm 0.015\%$ / °C max.
Dynamic load response 50% load change (upper half)	150 mV max. peak variation 250 μ S max. response time
Startup rise time 10 % to 90 % V_{out}	2 mS
Short circuit protection	continuous, automatic recovery
Current limitation	at 2.5 A typ.
Capacitive load	470 μ F max.

General Specifications

Temperature ranges	<ul style="list-style-type: none"> - Operating - Storage 	<ul style="list-style-type: none"> -40°C to +85°C (-40°F to +185°F) -55°C to +125°C (-67°F to +257°F)
Derating		2.4 %/K above 60°C
Thermal shock		acc. MIL-STD-810F
Humidity (non condensing)		95 % rel H max.
Reliability, calculated MTBF (MIL-HDBK217F, at +25°C, ground benign)		>5'350'000 h
Isolation voltage		none
Switching frequency		500 kHz $\pm 10\%$ (pulse width modulation)

Physical Specifications

Casing material	non-conductive plastic
Potting material	silicon (flammability to UL 94V-0 rated)
Package weight	1.9 g (0.07 oz)
Soldering profile	max. 265°C / 10 sec. (wave soldering)

All specifications valid at nominal input voltage, full load and +25°C after warm-up time unless otherwise stated.

THE HAMPTON SERIES

PHYSICAL DETAILS

- Round tapered symmetrical cross section.
- Standard taper of 15mm/metre (0.18"/foot).
- Standard mold, etched, exposed finishes are available in a variety of colours.
- Available in heights from 10 feet to 70 feet above grade.
- Will accept a variety of luminaire mounting styles.

HAMPTON SPECIFYING CHART

CLASS OF POLE	SPECIFYING POLE CODE (Style-Height-Class)	(A) POLE HEIGHT ABOVE GRADE (ft.)	(B) DIRECT BURIAL LENGTH (ft.)	(C) POLE TOP DIAMETER (in.)	(D) POLE BUTT DIAMETER (in.)	ULTIMATE GROUND LINE MOMENT (ft.lbs.)	NOMINAL POLE WEIGHT (lbs.)
AL	HA-150-AL	11	4	4 3/4	7 7/16	5400	450
	HA-175-AL	13 1/2	4	4 3/4	7 7/8	6900	575
	HA-200-AL	15	5	4 3/4	8 3/8	7800	700
	HA-225-AL	17 1/2	5	4 3/4	8 13/16	9300	820
	HA-250-AL	20	5	4 3/4	9 1/4	10800	940
A	HA-150-A	11	4	4 3/4	7 7/16	5400	450
	HA-175-A	13 1/2	4	4 3/4	7 7/8	6900	575
	HA-200-A	15	5	4 3/4	8 3/8	7800	700
	HA-225-A	17 1/2	5	4 3/4	8 13/16	9300	820
	HA-250-A	20	5	4 3/4	9 1/4	10800	940
	HA-275-A	22 1/2	5	4 3/4	9 11/16	12300	1095
	HA-300-A	25	5	4 3/4	10 1/8	13800	1250
	HA-325-A	27 1/2	5	4 3/4	10 5/8	15300	1410
	HA-350-A	30	5	4 3/4	11 1/16	16800	1575
B	HA-250-B	20	5	4 3/4	9 1/4	16200	940
	HA-275-B	22 1/2	5	4 3/4	9 11/16	18450	1095
	HA-300-B	25	5	4 3/4	10 1/8	20700	1250
	HA-325-B	27 1/2	5	4 3/4	10 5/8	22950	1410
	HA-350-B	30	5	4 3/4	11 1/16	25200	1575
	HA-375-B	32 1/2	5	4 3/4	11 1/2	27450	1770
	HA-400-B	34	6	4 3/4	11 15/16	29800	1965
	HA-425-B	36 1/2	6	4 3/4	12 3/8	31050	2130
	HA-450-B	39	6	4 3/4	12 7/8	33300	2300
C	HA-300-C	25	5	6	11 3/8	27600	1650
	HA-325-C	27 1/2	5	6	11 7/8	30600	1875
	HA-350-C	30	5	6	12 5/16	33600	2100
	HA-375-C	32 1/2	5	6	12 3/4	36600	2325
D	HA-400-D	34	6	6	13 3/16	48000	2550
	HA-425-D	36 1/2	6	6	13 5/8	51750	2775
	HA-450-D	39	6	6	14 1/8	55500	3000
	HA-475-D	41	6 1/2	6	14 9/16	59500	3225
	HA-500-D	43	7	6	15	61500	3450

NOTES: The above chart outlines standard typical heights and classes. Other sizes are available upon request. The Hampton series is available from 10 to 85 feet overall, in 6" increments. It's also available from class "AL" to class "D". Pole height above grade based on recommended burial depth for normal soils. Ultimate ground line moment is calculated as follows: Height above grade minus 2 ft. times transverse bending strength.

TYPICAL POLE DETAIL

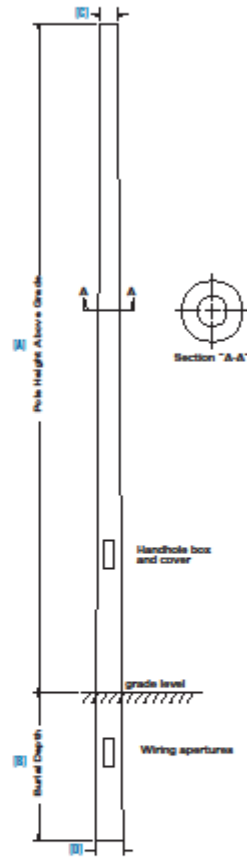

CROSS SECTION



81 BONGARD AVENUE, OTTAWA, ONTARIO CANADA K2E 6V2
 TEL: (613) 225-6388 • FAX: (613) 225-1881 • TOLL FREE: 1-800-267-6468
 www.utiltystructures.com

12/8/2014

SCE | Part Information - SCE-161410CHNF

*Your Enclosure Source*®

Saginaw Control & Engineering
 95 Midland Road
 Saginaw, MI 48638-5770
 Phone: (800)234-6871
 Fax: (989)799-4524
<http://www.saginawcontrol.com>

Part Information - SCE-161410CHNF

■ SCE-161410CHNF

Application -

Designed for use as electrical junction boxes, terminal wiring boxes, instrument housings, and electrical control enclosures. Provides protection from dust, dirt, oil and water.

Construction -

- 0.063" carbon steel.
- Seams continuously welded and ground smooth, no holes or knockouts.
- Continuous hinge with stainless steel hinge pin.
- Stainless steel external screw clamps are quick and easy to operate.
- Oil resistant door gasket.
- Standoffs provided for mounting optional panels.
- Ground stud on door & body.

Finish -

ANSI-61 gray powder coating inside and out. Optional sub-panels are powder coated white.

Industry Standards - (IS2)

NEMA Type 4, 12 and Type 13
 UL Listed Type 4 and 12
 CSA Type 4 and 12
 IEC 60529 IP 66

Notes -

Part numbers containing an "S" are hinged on the short side.

Product Specifications -

Part Number: SCE-161410CHNF
 Description: CHNF Enclosure
 Height: 16.00"
 Width: 14.00"
 Depth: 10.00"
 Price Code: A1
 List Price: \$150.70
 Catalog Page: 66
 Est. Ship Weight: 26.00 lbs



[Download CAD Package](#)
[Add to Bill of Material](#)

Optional Accessories -

SCE-16P14 - Subpanel, Flat
 SCE-BV4XKIT - Kit, Breather Vent
 SCE-DFJ1614 - Dead Front, ELJ & CH
 SCE-DV4XKIT - Kit, Drain Vent
 SCE-PLKJIC - Padlock Kit
 SCE-QR1 - Quick Release Clamp Assembly CH Style (Chrome)

Similar Part Numbers -

SCE-404CHNF - CHNF Enclosure
 SCE-4044CHNF - CHNF Enclosure
 SCE-604CHNF - CHNF Enclosure
 SCE-6044CHNF - CHNF Enclosure
 SCE-606CHNF - CHNF Enclosure
 SCE-806CHNF - CHNF Enclosure
 SCE-8066CHNF - CHNF Enclosure
 SCE-808CHNF - CHNF Enclosure
 SCE-8086CHNF - CHNF Enclosure
 SCE-1008CHNF - CHNF Enclosure

Installation Information -

[Drain/Vents](#)
[Dead Front CH & ELJ Style Installation Instructions](#)

Saginaw Control and Engineering
 95 Midland Road
 Saginaw, MI 48638-5770
 (800)234-6871
 Fax: (989)799-4524
SCE@SaginawControl.com

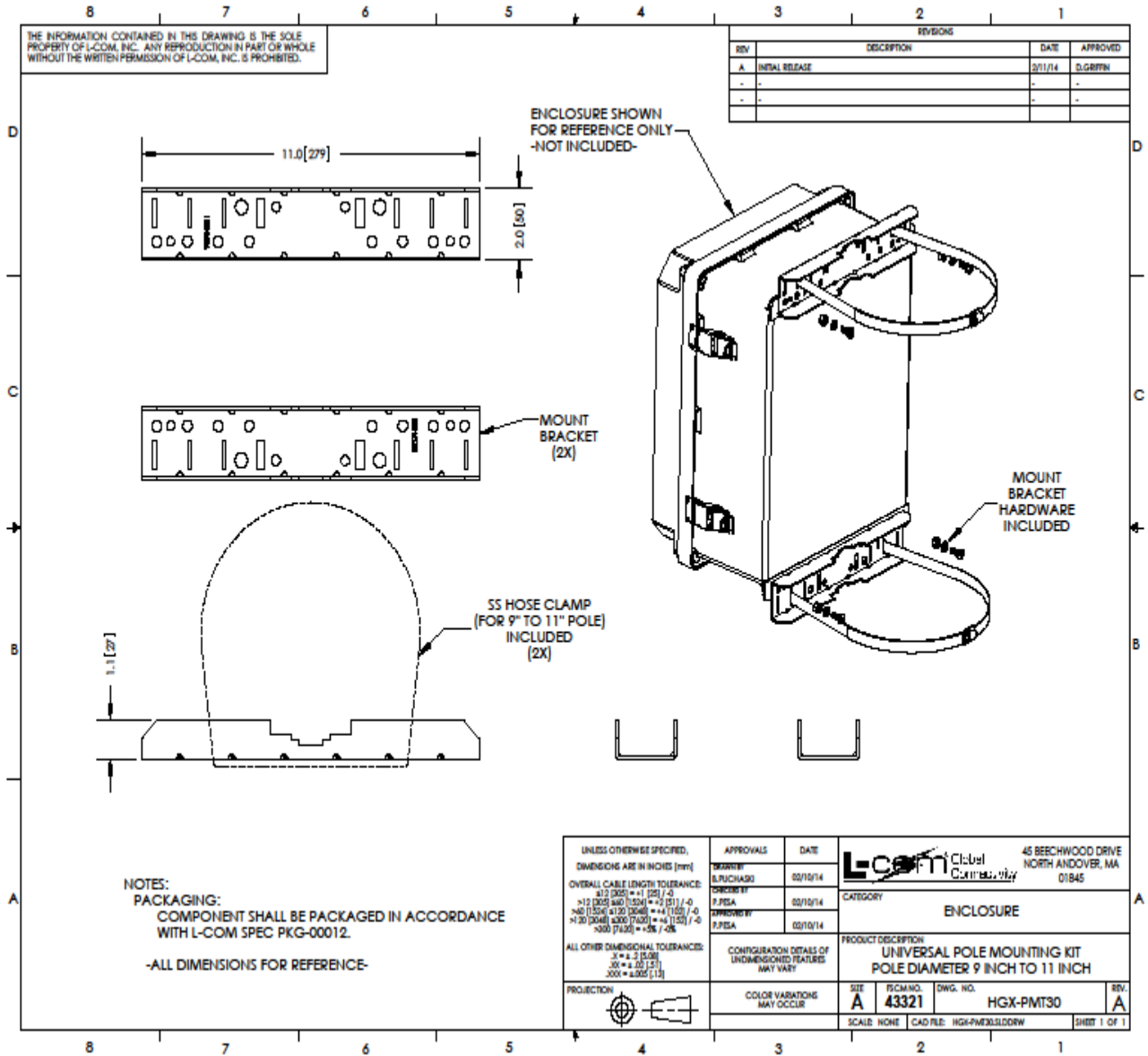

APPENDIX 4: FEM MOUNT & COMPONENT ANALYSIS RESULTS

TABLE 4-1A: COMPONENT WEIGHT BREAKDOWN		
COMP1	COMP2	COMP3
<i>lbf</i>	<i>lbf</i>	<i>lbf</i>
20.00	89.58	26.50

TABLE 4-2A: WIND FORCE SIMULATION RESULTS							
COMPONENT	FRONT	BACK	TOP	BOTTOM	RIGHT	LEFT	NET FORCE
	<i>lbf</i>	<i>lbf</i>	<i>lbf</i>	<i>lbf</i>	<i>lbf</i>	<i>lbf</i>	<i>lbf</i>
Camera	28.44	12.00	0.05	0.04	0.02	0.03	40.57
Pan-Tilt	19.80	7.90	0.03	0.02	0.04	0.03	27.81
Enclosure	55.76	20.55	0.10	0.11	0.10	0.09	76.71
Pole	334.30	610.45					944.75
Solar Panel	84.04	112.62	12.95	15.55	0.03	0.03	225.22

TABLE 4-2B: FORCE ON COMPs VS POLE	
COMPs	POLE
<i>lbf</i>	<i>lbf</i>
370.32	944.75

TABLE 4-3A: COMPONENT EPA AT 150 MPH			
COMPONENT	DRAG COEF.	NET FORCE	EPA
	<i>lbf/in²</i>	<i>lbf</i>	<i>in²</i>
COMP1	2.10	68.39	32.57
COMP2	2.10	76.71	36.53
COMP3	1.40	225.22	160.87

TABLE 4-3B: NET EPA AT 150 MPH	
<i>in²</i>	<i>ft²</i>
229.97	1.60

TABLE 4-4A: ORIENTATION HEIGHTS		
A	B	C
<i>ft</i>	<i>ft</i>	<i>ft</i>
15	12	3

APPENDIX 5: PROTOTYPE SPECIFICATIONS

FLIR A655sc**High-Resolution LWIR Science-Grade Infrared Camera**

With its uncooled detector, high resolution, and all of the cutting-edge functionality scientists and researchers have come to expect from FLIR, the A655sc brings affordable research and science thermal imaging and measurement to a whole new level.

Affordable, Compact, and Powerful – The A655sc provides over 300,000 pixels of accurate temperature measurement data.

Uncooled Microbolometer Detector – Maintenance-free and provides excellent longwave imaging performance.

High Resolution – 640 × 480, 17 micron pixel detector provides great image detail and small spot size for accurate measurements of small temperature anomalies.

Full Frame Rate – Provides 14-bit data up to 50 frames per second at full frame 640 × 480 resolution.

FPA Windowing – Provides high-speed windowing modes (up to 200 Hz with a 640 × 120 window) and digital control of image flow and recording to FLIR's R&D software.

Fully Compliant – With both GenICam and GigE Vision protocols, the A655sc is ready to integrate with a variety of third-party analysis software packages.

Perfect for Research and Science

Applications – The A655sc helps you to see and accurately quantify heat patterns, leakage, dissipation, and other heat-related factors in equipment, products, and processes in real time.

Included Recording & Analysis Software – Remotely control the A655sc, record thermal snap-shots and movies, measure temperature from over 300,000 spots, create temperature verses time plots, and more with the included FLIR ResearchIR software.

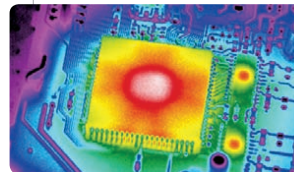

Microchip

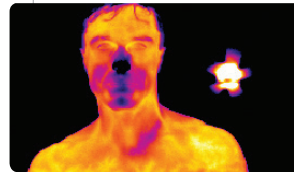

Medical



Space Shuttle



Imaging Specifications

Detector	
Detector Type	A655sc Uncooled Microbolometer
Spectral Range	7.5 – 14.0 μ m
Resolution	640 x 480
Detector Pitch	17 μ m
NETD	<50 mK
Imaging	
Time Constant	<8 ms
Frame Rate (Full Window)	50 Hz
Subwindow Mode	User-Selectable 640 x 240 or 640 x 120
Maximum Frame Rate (@ Min. Window)	200 Hz (640 x 120)
Dynamic Range	14-bit
Digital Data Streaming	Gigabit Ethernet (50/100/200 Hz) USB (25/50/100 Hz)
Command and Control	Gigabit Ethernet, USB
Measurement	
Standard Temperature Range	-40°C to 150°C (-40°F to 302°F) 100°C to 650°C (212°F to 1,202°F)
Optional Temperature Range	Up to 2,000°C (3,632°F)
Accuracy	\pm 2°C or \pm 2% of Reading
Optics	
Camera f/#	f/1.0
Available Lenses	13.1 mm (45") 24.5 mm (24") 41.3 mm (15")
Focus	Automatic or Manual (Motorized)
Close-up / Microscopes	Close-up 50 μ m, 100 μ m
Image Presentation	
Digital Data	Via PC Using ResearchIR Software
General	
Operating Temperature Range	-15°C to 50°C (5°F to 122°F)
Storage Temperature Range	-40°C to 70°C (-40°F to 158°F)
Encapsulation	IP 30 (IEC 60529)
Bump / Vibration	25 g (IEC 60068-2-29) / 2 g (IEC 60068-2-6)
Power	12/24 VDC, 24 W Absolute Max.
Weight	0.9 kg (1.98 lb)
Size (L x W x H) w/o Lens	216 x 73 x 75 mm (8.5 x 2.9 x 3.0 in)
Mounting	1/4"-20 (on three sides), 2 x M4 (on three sides)

Back Panel



- ① Power Connector, Screw Terminal 2-pole: 10 – 30 VDC; 24 W Max.
- ② Gigabit Ethernet Port, 1000 MB, RJ-45 Connector: Control and image streaming.
- ③ USB HS Connector: Camera control and image streaming.
- ④ Digital I/O Connector, Screw Terminal 6-pole: Digital Out: 2 outputs, opto-isolated, 10–30 VDC supply, 100 mA. Digital In: 2 inputs, opto-isolated, 10–30 VDC.

A655sc Packages

A655sc ResearchIR Recording & Analysis Package:
A655sc, 24.5 mm (24") Lens, Standard Temperature Calibration, ResearchIR Software

A655sc ResearchIR Max Recording & Analysis Package:
A655sc, 24.5 mm (24") Lens, Standard Temperature Calibration, ResearchIR Max Software

*Ask your FLIR representative about additional packages



BOSTON
FLIR Systems, Inc.
9 Townsend West
Nashua, NH 03063
USA
PH: +1 866.477.3687

PORTLAND
Corporate Headquarters
FLIR Systems, Inc.
27700 SW Parkway Ave.
Wilsonville, OR 97070
USA
PH: +1 866.477.3687

CANADA
FLIR Systems, Ltd.
920 Sheldon Ct.
Burlington, ON L7L 5L6
Canada
PH: +1 800.613.0507

MEXICO/LATIN AMERICA
FLIR Systems Brasil
Av. Antonio Bardella
320 - B. Boa Vista - Cep:
18085-852 - Sorocaba - SP - Brazil
PH: +55 15 3238 8070

www.flir.com
NASDAQ: FLIR

Equipment described herein may require US Government authorization for export purposes. Diversion contrary to US law is prohibited. Imagery for illustration purposes only. Specifications are subject to change without notice. ©2012 FLIR Systems, Inc. All rights reserved. 3445 (Rev. 4/13)

RNG-150D

Key Features

- Top Ranked PTC Rating
- High Module Conversion Efficiency
- Fast and Inexpensive Mounting
- Maximizes System Output by Reducing the mismatch Loss
- 100% EL Testing on Every Renogy Modules, Guaranteed No Hot Spot
- Guaranteed Positive Output Tolerance (0+3%)
- Withstands High Wind (2400 Pa) and Snow Loads (5400 Pa)
- Excellent Performance in Low Light Environments

Application

- Off-Grid Rooftop/Ground Mounted
- Residential/Rural
- 12 V Battery Charging

Electrical Characteristics

Maximum Power at STC (Pmax)	150 W
Optimum Operating Voltage (Vmp)	17.9 V
Optimum Operating Current (Imp)	8.38 A
Open-Circuit Voltage (Voc)	22.5 V
Short-Circuit Current (Isc)	9.05 A
Cells Efficiency	19.0%
Maximum System Voltage	

Mechanical Characteristics

Solar Cell	Monocrystalline 156 x 16mm
No. of Cells	36 (6 x 6)
Dimensions	1000 x 990 x 35 mm (39.5 x 39 x 1.4 inches)
Weight	11.5 kgs (25.5 lbs)
Front Glass	3.2 mm (0.13 inches) tempered glass
Frame	Anodized aluminum alloy
Junction Box	IP65 rated
Output Cables	4.0 mm ² (0.006 inches ²), 1000mm (39.3 inches)
Connectors	MC4 connectors
Fire Rating	Classs C



Module Diagram

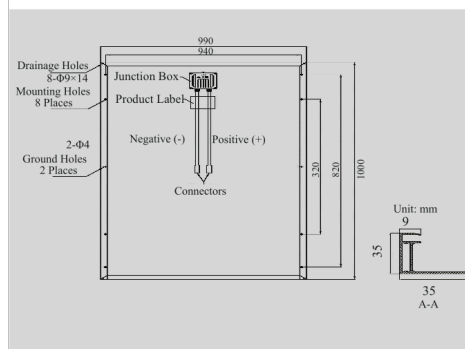

Maximum Ratings

Operating Module Temperature	-40°C to +80°C
Maximum Series Fuse Rating	15 A

Temperature Characteristics

Nominal Operating Cell Temperature (NOCT)	47±2°C
Temperature Coefficient of Pmax	-0.44%/°C
Temperature Coefficient of Voc	-0.30%/°C
Temperature Coefficient of Isc	0.04%/°C

©2013 Renogy,LLC. All rights reserved. Contents included in this datasheet are subject to change without notice.



APPENDIX 6: COMPLETE PROJECT GANTT CHART

